

Übersicht Sicherheitskontaktleisten GE-Serie

Overview safety contact edges GE-series

Standardprofile ohne Dichtlippen

Standard profiles without sealing rims

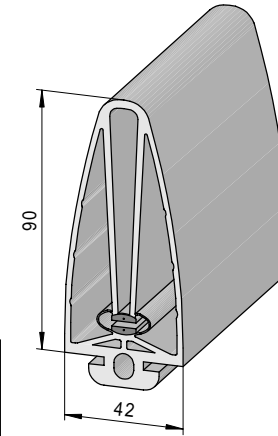
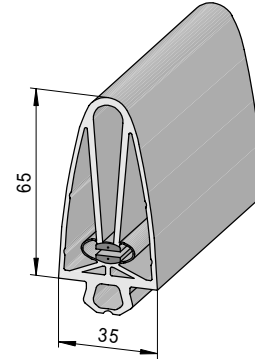
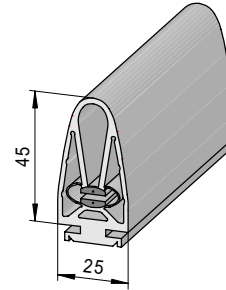
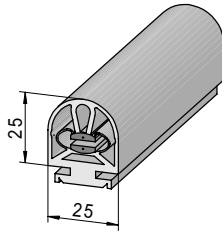
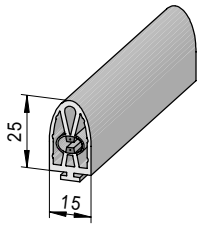

Typ Artikel Nr.	GE 125 TT 101110	GE 225 TK 101120	GE 245 TK 101140	GE 365 CK 101161	GE 490 TK 101190	Type Article No.
Zulassungen	<i>aktuelle Prüfzertifikate können angefordert werden</i>			<i>current test certification can be requestet</i>		Licence
C-Profile:	AL 15-9	AL 25-14 AL 25-10V AL 25-10H	AL 25-14 AL 25-10V AL 25-10H	AL 35-14 AL 35-15HB	AL 35-14 AL 35-15HB	C-profile
Material	TPE	EPDM	EPDM	EPDM	EPDM	Material
Lieferlänge	25 m	25 m	25 m	25 m	25 m	Delivery length
Gewicht Kg/ m	0,18			1,1	1,74	Weight Kg/m
Zubehör						Equipment
Anschlußstecker	KS 3 L x.x m	KS 5 L x.x m	KS 5 L x.x m	KS 5 L x.x m	KS 5 L x.x m	Connecting Plug
Abschlußstecker	KS 3 W	KS 5 W	KS 5 W	KS 5 W	KS 5 W	Terminal Plug
Endkappe	EK 125 T	EK 225 T	EK 245 T	EK 365 T		End Cap
Aufsatzpuffer	AP 15-30	AP 15-30	AP 25-47	AP 35-70		Stopper
<i>Prüfung nach EN 1760-2, Geschwindigkeit 10 mm/s, Temp. 20°C, Prüfkörper rund Ø 80mm, Betätigungspunkt C3</i>				<i>Tested according EN 1760-2, Speed 10 mm/s, Temp. 20°C, Test Unit Ø 80mm round, Actuating Point C3</i>		
<i>Betätigungskraft F_A/N</i>						<i>Actuating Force F_A/N</i>
<i>Ansprechweg S_B/mm</i>						<i>Actuating Distance S_B/mm</i>
<i>Nachlaufweg S_V/mm</i>						<i>Overtravel Distance S_V/mm</i>
<i>Prüfung nach EN 1760-2, Geschwindigkeit 100 mm/s, Temp. 20°C, Prüfkörper rund Ø 80mm, Betätigungspunkt C3</i>				<i>Tested according EN 1760-2, Speed 100 mm/s, Temp. 20°C, Test Unit Ø 80mm round, Actuating Point C3</i>		
<i>Betätigungskraft F_A/N</i>						<i>Actuating Force F_A/N</i>
<i>Ansprechweg S_B/mm</i>						<i>Actuating Distance S_B/mm</i>
<i>Nachlaufweg S_V/mm</i>						<i>Overtravel Distance S_V/mm</i>

Übersicht Sicherheitskontaktleisten GE-Serie

Overview safety contact edges GE-series

Standardprofile mit Dichtlippen

Standard profiles with sealing rims

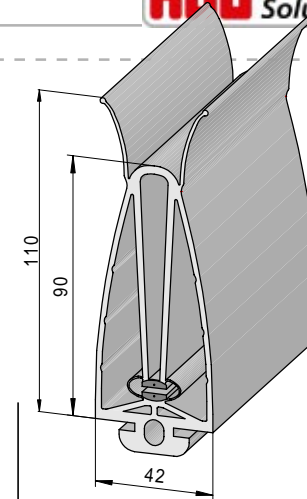
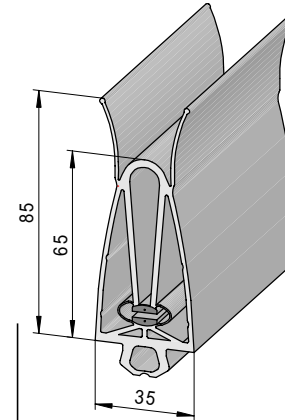
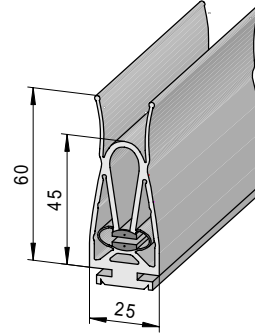
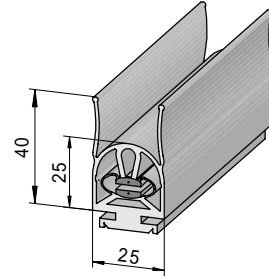
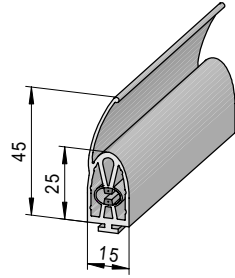

Typ Artikel Nr.	GE 125 TTLi 101115	GE 225 TKLL 101126	GE 245 TKLL 101146	GE 365 CKLL 101167	GE 490 TKLL 101196	Type Article No.
Zulassungen	<i>aktuelle Prüfzertifikate können angefordert werden</i>			<i>current test certification can be requestet</i>		Licence
C-Profile:	AL 15-9	AL 25-14 AL 25-10V AL 25-10H	AL 25-14 AL 25-10H AL 25-10H	AL 35-14 AL 35-15HB	AL 35-14 AL 35-15HB	C-profile
Material	TPE	EPDM	EPDM	EPDM	EPDM	Material
Lieferlänge	25 m	25 m	25 m	25 m	25 m	Delivery length
Gewicht Kg/ m	0,2			1,25	1,9	Weight Kg/m
Zubehör						Equipment
Anschlußstecker	KS 3 L x.x m	KS 5 L x.x m	KS 5 L x.x m	KS 5 L x.x m	KS 5 L x.x m	Connecting Plug
Abschlußstecker	KS 3 W	KS 5 W	KS 5 W	KS 5 W	KS 5 W	Terminal Plug
Endkappe	EK 125 TL	EK 225 TL	EK 245 TL	EK 365 TL		End Cap
Aufsatzpuffer	AP 15-30	AP 15-30	AP 25-47	AP 35-70		Stopper
<i>Prüfung nach EN 1760-2, Geschwindigkeit 10 mm/s, Temp. 20°C, Prüfkörper rund Ø 80mm, Betätigungspunkt C3</i>				<i>Tested according EN 1760-2, Speed 10 mm/s, Temp. 20°C, Test Unit Ø 80mm round, Actuating Point C3</i>		
<i>Betätigungskraft F_A/N</i>						<i>Actuating Force F_A/N</i>
<i>Ansprechweg S_B/mm</i>						<i>Actuating Distance S_B/mm</i>
<i>Nachlaufweg S_V/mm</i>						<i>Overtravel Distance S_V/mm</i>
<i>Prüfung nach EN 1760-2, Geschwindigkeit 100 mm/s, Temp. 20°C, Prüfkörper rund Ø 80mm, Betätigungspunkt C3</i>				<i>Tested according EN 1760-2, Speed 100 mm/s, Temp. 20°C, Test Unit Ø 80mm round, Actuating Point C3</i>		
<i>Betätigungskraft F_A/N</i>						<i>Actuating Force F_A/N</i>
<i>Ansprechweg S_B/mm</i>						<i>Actuating Distance S_B/mm</i>
<i>Nachlaufweg S_V/mm</i>						<i>Overtravel Distance S_V/mm</i>

Sonderprofile
Special profiles

In Bearbeitung

Under Construction