

Safety relay JSBRT11

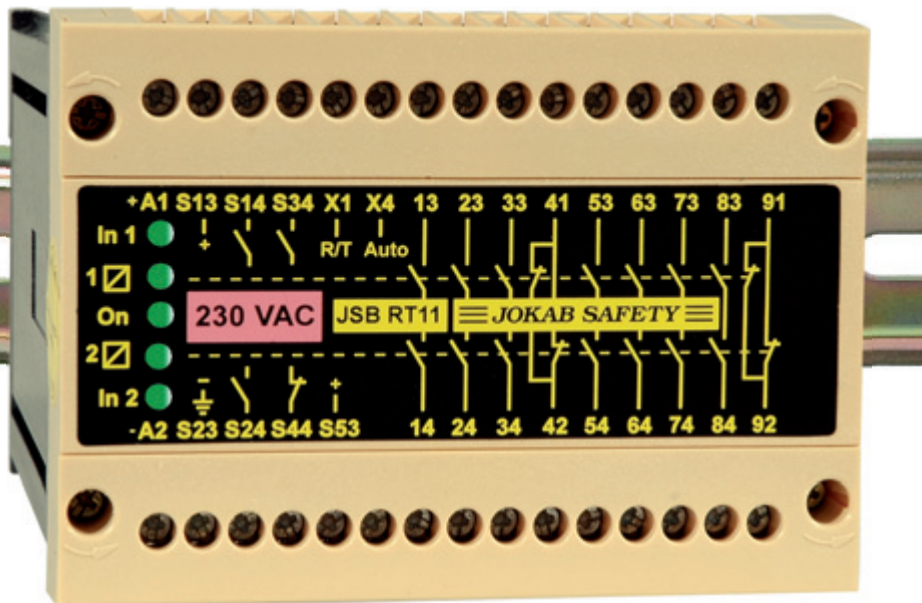

Approvals:



Safety relay for:

Emergency stop
Light curtains
Three position devices
Interlocked gates/hatches
Magnetic switches
Light beams
Foot operated switches

A flexible safety relay with many outputs

The JSBRT11 has been designed to provide the safety system circuit designer with the ability to select from both a range of input connection configurations and either automatic or supervised reset.

The unit can be hardwire configured to operate in either of the following input configurations:

- Mode 1: Single Channel (1 NO contact from +24 VDC), safety category 1.
- Mode 2: Dual Channel (2 NO contacts from +24 VDC), safety category 3.
- Mode 3: Dual Channel (1 NO, 1NC contacts from + 24 VDC), safety category 4.
- Mode 4: Dual Channel (1 NO contact from 0 V and 1 NO contact from + 24 VDC), safety category 4.

In addition the unit can also be used to test that contactors and valves have fallen/returned to their 'reset' state before a new 'start' signal is given.

Safety level

The JSBRT11 has dual and monitored internal safety functions. Power failure, internal component failures or external interference (with the exception of short circuiting of input contact when used in a single channel input mode) do not result in a dangerous function.

When wired for supervised reset, should a short circuit appear across the reset input the relay will not automatically reset when the input/inputs are made. Only when the supervised reset input is made and broken will the relay reset.

The JSBRT11 provides detection of contact failure in the inputs when wired in dual channel mode. Both inputs have to be opened and closed in order to enable the reactivation of the relay.

The highest safety level of the JSBRT11 is in configuration mode 3 and 4 because all short circuits are supervised i.e. a short circuit between the inputs leads to a safe state as the outputs drop out.

Regulations and standards

The JSBRT11 is designed and approved in accordance with appropriate directives and standards. Examples of such are 98/37/EC, EN ISO 12100-1/-2, EN 60204-1 and EN 954-1/ EN ISO 13849-1.

Connection examples

For examples of how our safety relays can solve various safety problems, please see the section "Connection examples".

Features:

Selectable inputs and safety category
Manual supervised or automatic reset
Width 100 mm
LED indication for supply, inputs and outputs
7 NO + 2 NC relay outputs
Supply 24 VDC 24, 48, 115 or 230 VAC
Quick release connector blocks

Technical data - JSBRT11

Manufacturer:	JOKAB SAFETY AB, Sweden
Colour:	Black and Beige
Power supply A1 - A2:	24 VDC +/- 15% 24, 48, 115, 230 VAC +/- 15%, 50-60 Hz
Power consumption:	< 3 VA
Relay Outputs:	7 NO and 2 NC
Max. switching capacity res. load AC:	6A/250 VAC/1500 VA
Max. switching capacity res. load DC:	6A/24 VDC/150 W
Max. total switching capacity:	21A distributed on all contacts
Min. load:	10mA/10 V (if load on contact has not exceeded 100 mA)
Contact material	AgSnO ₂ + Au flash
Max. Input wire res. at nom. voltage:	200 Ohm (S14,S24,S34,X1,X4); 100 Ohm (S44)
Response time at deactivation (input-output):	<20 ms
Response time at activation (input-output):	<30 ms
Terminals (Max. screw torque 1 Nm):	Single strand: 1x4 mm ² /2x1.5 mm ² Conductor with socket contact: 1x2.5 mm ² /2x1 mm ²
Mounting:	35 mm DIN-rail
Protection class, enclosure:	IP 40 IEC 60259
terminals:	IP 20 IEC 60259
Air and creep distance:	4 kV/2 IEC 60664-1
Operating temperature range:	-10°C to +55°C
Function indication:	Electrical Supply, Input 1 and 2, Output relays 1 and 2
Weight:	610 g (24 VDC) 790 g (24-230 VAC)

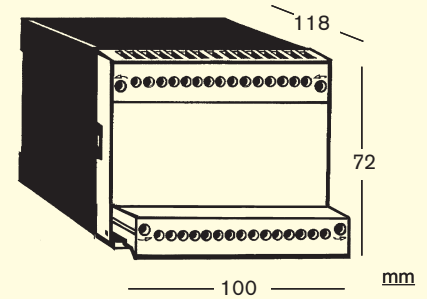

Connector blocks are detachable
(without cables having to be disconnected)

Article number/Ordering data:

10-025-00	24DC
10-025-02	24AC
10-025-03	48AC
10-025-04	115AC
10-025-05	230AC

Technical description - JSBRT11

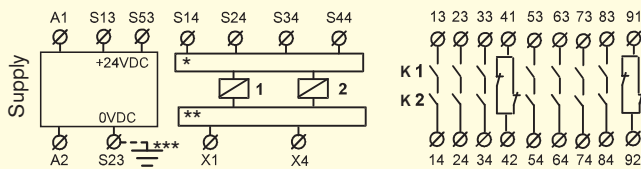

*Supervision circuit **Test and Automatic reset circuit *** Only for AC-supply

The supply voltage is connected across A1 and A2. The input connection configuration and type of reset required is set by connecting the unit as shown in the diagrams below.

When the input/inputs and the test/supervised reset are made K1 and K2 energise. K1 and K2 will de-energize if the power is disconnected or a stop signal is given in accordance to the configuration mode wired. Both K1 and K2 have to be de-activated before the outputs of the JSBRT11 can be closed again.

Configuration mode 1.

When the single input opens both K1 and K2 relays are deactivated.

Configuration mode 2.

Both inputs have to be closed in order to enable the unit to be activated. A stop signal is given if both or one input is opened. Both inputs have to be opened and reclosed in order to enable the reactivation of the unit. If the possibility of short circuits between the inputs cannot be excluded, configuration mode 3 or 4 should be used in order to reach the highest safety level.

Configuration mode 3.

One input has to be closed and the other input has to be opened in order to enable the unit to be activated. A stop signal is given if both or one input change state.

Both inputs have to change state in order to give a dual stop function and to allow a new start after stop.

Configuration mode 4

Operation as mode 2 but short circuits between the inputs leads to a safe state i.e. the relays inside the JSBRT11 will drop out.

Supervised reset connection.

The input to X1 (see diagram below) has to be closed and opened in order to activate the unit, after input/inputs are made according to the configuration mode selected. This mode is selected when X1 - X4 is open-circuit.

Automatic reset connection.

The input has to be closed in order to activate the unit after input/inputs are made according to the configuration mode selected. This mode is selected when a connection between X1 and X4 is made.

Test.

Test contacts of contactors can be connected between S53 and X1 for supervision.

Electrical connection - JSBRT11

SINGLE CHANNEL *, 1 NO from +24V



DUAL CHANNEL*, 1 NO, 1 NC from +24V

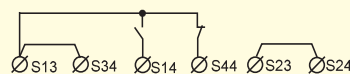

Supervised manual reset

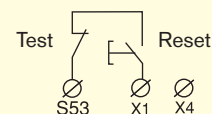

DUAL CHANNEL*, 2 NO from +24V

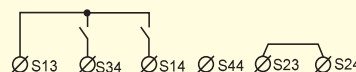

DUAL CHANNEL*, 1 NO from +24V, 1 NO from 0V

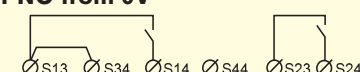

Automatic reset

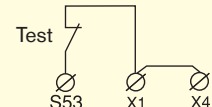

It is recommended that all switched loads are adequately suppressed and/or fused in order to provide additional protection for the safety contacts.

* With the input conditions shown, the JSBRT11 is in its de-energized state, i.e. output contacts are open.