

GP-4201TM/4301TM Installation Guide

Please read the "Warning/Caution Information" on the attached sheet before using the product.

Table of Contents

Package Contents	2
About the Manual	3
Electrical Specifications	4
Parts Identification and Functions	4
Serial Interface	6
Installation	8
1. Installation Requirements	8
2. Panel Cut-out Dimensions	9
3. Installation Procedures	10
Wiring	12
1. Power Cord Specifications	12
2. Power Connector Specifications	13
3. How to Connect the Power Cord	13
4. Wiring Cautions	14
USB Clamp	15
1. Attaching the USB Clamp	15
2. Removing the USB Clamp	17
Relevant Standards	18

Package Contents

Verify all items listed here are present in your package:

1

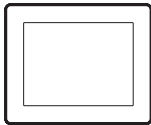

2

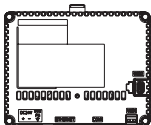

3

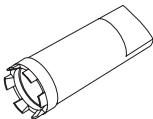

4



5



6



7



- 1 Display Module (1)
- 2 Rear Module (1)
- 3 Socket Wrench (1)
- 4 USB Clamp Type A (1 port) (1)
- 5 Anti-rotation Tee (1)
- 6 DC Power Connector (1)
- 7 Display Installation Nut
(1, attached to the Display Module)
- 8 GP-4201TM/4301TM Installation
Guide (1) <this guide>
- 9 Warning/ Caution Information (1)

About the Manual

This manual describes wiring and installation procedures. For more detailed information, refer to the manuals indicated below.

Manual	Contents
GP-4201TM/ 4301TM Hardware Manual	Specifications, dimensions, accessories, system design, overseas standards, and other details.
Device/PLC Connection Manual	System configuration of connected devices (PLCs and other devices), communication settings examples, connection wiring diagram, and other details.
Maintenance/ Troubleshooting	<ul style="list-style-type: none">• Troubleshooting Help for solving problems.• Maintenance Details on the GP unit's Offline Mode

The manuals can be selected from the help menu of GP-Pro EX or downloaded from Pro-face Home Page.

URL
http://www.pro-face.com/otasuke/

Electrical Specifications

	Rated Input Voltage	Input Voltage Limits	Voltage Drop	Power Consumption	In-Rush Current	Voltage endurance	Insulation Resistance
GP-4201TM	24 Vdc	20.4... 28.8 Vdc	10 ms or less	6.5 W or less	30 A or less	1,000 Vac 20 mA for 1 min (between charging and FG terminals)	500 Vdc, 10 M Ω or more (between charging and FG terminals)
GP-4301TM	24 Vdc	20.4... 28.8 Vdc	7 ms or less	6.8 W or less	30 A or less	1,000 Vac 20 mA for 1 min (between charging and FG terminals)	500 Vdc, 10 M Ω or more (between charging and FG terminals)

Parts Identification and Functions

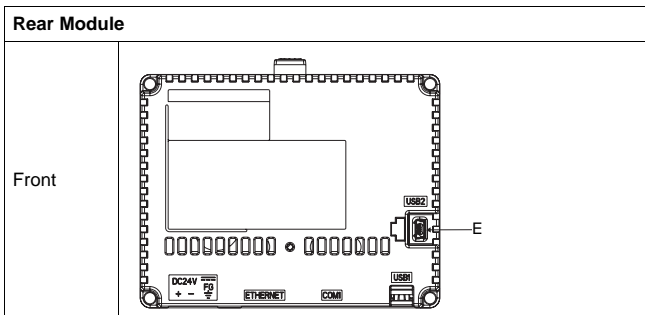

Rear Module

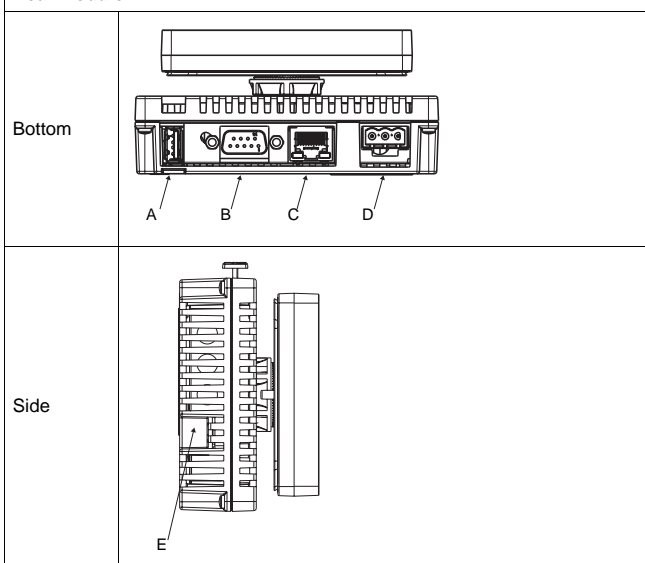

Part	Description
A	USB (Type A) interface connector: connects the memory stick to the unit.
B	Serial I/F (host I/F): connects a RS232C/RS422/RS485 cable (from the host/PLC) to the GP unit. D-Sub 9-pin plug type connector.
C	Ethernet Interface (LAN): connects an Ethernet cable (from the host/PLC) to the unit.
D	DC Power Connector (plug) :connects the power input and ground wires to the unit.
E	USB (mini-B) interface connector: connects the data transfer PC cable to the unit.

Serial Interface

NOTE: For instructions on how to connect to other devices, always refer to the "GP-Pro EX Device/PLC Connection Manual".

DANGER

ELECTRIC SHOCK

The serial port is not isolated. The SG (signal ground) and the FG (frame ground) terminals are connected inside the unit. When using the SG terminal to connect an external device to the unit:

- Verify that a short-circuit loop is not created when you set up the system.
- Connect the #5 SG terminal to remote equipment when the host (PLC) unit is not isolated. Connect the #5 SG terminal to a known reliable ground connection to reduce the risk of damaging the RS232C/RS422/RS485 circuit.

Failure to follow these instructions will result in death or serious injury.

CAUTION

LOSS OF COMMUNICATION

- All connections to the communication ports must not put excessive stress on the ports.
- Securely attach communication cables to the panel or cabinet.

Failure to follow these instructions can result in injury or equipment damage.

GP-4201TM/4301TM: D-Sub 9 pin plug connector via an RS-232C/RS-422/RS-485 cable.

Interfit bracket is #4-40 (UNC).

Pin No.	RS-232C		RS-422/RS-485	
	Signal Name	Meaning	Signal Name	Meaning
1	CD	Carrier Detect	RDA	Receive Data A(+)
2	RD(RXD)	Receive Data	RDB	Receive Data B(-)
3	SD(TXD)	Send Data	SDA	Send Data A(+)
4	ER(DTR)	Data Terminal Ready	ERA	Data Terminal Ready A(+)
5	SG	Signal Ground	SG	Signal Ground
6	DR(DSR)	Data Set Ready	CSB	Send Possible B(-)
7	RS(RTS)	Request to Send	SDB	Send Data B(-)
8	CS(CTS)	Send Possible	CSA	Send Possible A(+)
9	CI(RI)	Called status display	ERB	Data Terminal Ready B(-)
Shell	FG	Frame Ground (Common with SG)	FG	Frame Ground (Common with SG)

Installation

1. Installation Requirements

Mount the unit in an enclosure that provides a clean, dry, robust and controlled environment (IP65f enclosure or UL508 4x, if indoors.)

Before installing the GP unit verify that:

- The gasket is flat and not damaged.
- The installation panel or cabinet surface is flat (planarity tolerance: 0.5 mm (0.019 in.)), in good condition and has no jagged edges. Metal reinforcing strips may be attached to the inside of the panel, near the panel cut-out, to increase the rigidity.
- The panel must be designed to avoid any induced vibration resonance on the rear module exceeding a punctual factor of 10 and to avoid any induced permanent vibration resonance.
To reduce the resonance use the spacer supplied in the Accessories kit (sold separately).
- The ambient operating temperature and the ambient humidity are within their specified ranges. (Surrounding air temperature: 0 to 50°C (32 to 122°F), Ambient humidity :85%RH, Wet bulb temperature: 39°C (102.2°F) max.)
- The heat from surrounding equipment does not cause the unit to exceed its specified operating temperature (Surrounding air temperature: 0 to 50°C (32 to 122°F).
- The panel face is not inclined more than 30° when installing the unit in a slanted panel:

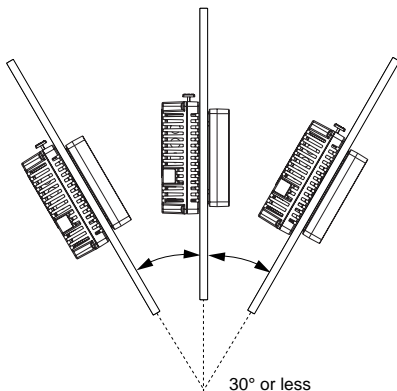

- When mounting the GP unit vertically, ensure that the right side of the unit faces up (i.e. the yellow button should be at the left).

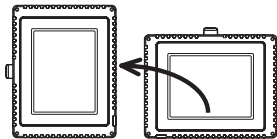

- The unit is at least 100 mm (3.94 in.) away from adjacent structures and other equipment for easier maintenance, operation and improved ventilation:

mm
in.

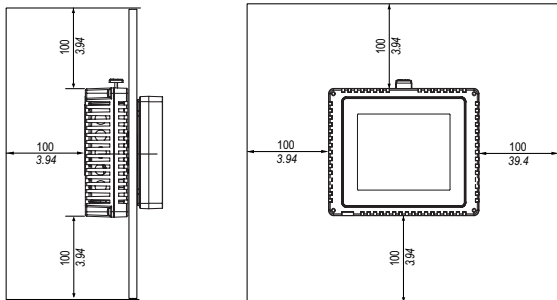

2. Panel Cut-out Dimensions

Create a panel cut-out and insert the display module of the unit into the panel from the front. The following illustration shows the panel cut-out for a GP unit :

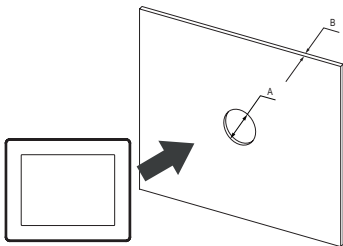

Dimensions

Unit	A (mm)	A (in.)	B (mm) (1)	B (in.)(1)	B (mm) (2)	B (in.) (2)
GP-4201TM	+0	+0	1.5 to 6	0.06 to 0.23	3 to 6	0.11 to 0.23
GP-4301TM	22.50	0.88				
	-0.30	-0.01				

The material of the panel

(1) Steel

(2) Glass fiber reinforced plastics (minimum GF30)

3. Installation Procedures

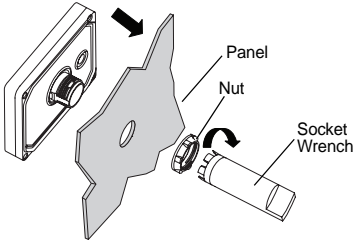
Step	Action
1	Place the unit on a clean and level surface with the display panel facing downward.
2	<p>The panel thickness depends on the material:</p> <ul style="list-style-type: none"> • Steel: 1.5 to 6 mm (0.06 to 0.23 in.) • Glass fiber reinforced plastics (minimum GF30): 3 to 6 mm (0.11 to 0.23 in.) <p>If the panel thickness is less than the above values, use the spacer in Accessories kit (sold separately). For the panel thickness and materials when using the spacer, please refer to "GP-4201TM/4301TM Hardware Manual"- "Installation".</p>
3	<p>Create the correct sized holes required to install the unit, using the Panel Cut-out Dimension (see page 9).</p> <p>NOTE: The field wiring opening for controller when mounted onto an enclosure shall have an area of not more than 775 mm² (1.2 in²).</p>
4	<p>Insert the display module into the panel hole:</p>  <p>Screw the nut with the socket wrench with a torque between 1.2 and 2 N•m (10.62 and 17.70 in-lb)</p>

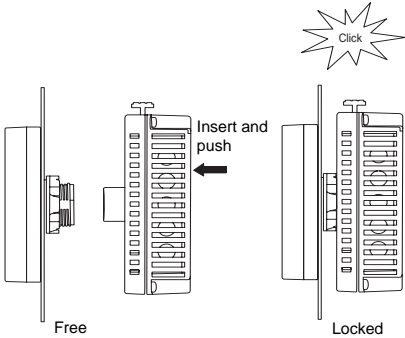
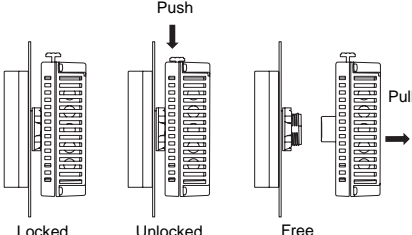
<p>5</p>	<p>Insert and push the rear module until it locks into place: NOTE: Install the display module and the rear module unit in the orientation shown in the illustration. If either unit is installed incorrectly, the connector may be damaged.</p> 
<p>6</p>	<p>To remove the rear module, push the yellow button to unlock it, then pull the rear module out:</p> 

NOTE:

An Anti-rotation Tee is included in the package. It's appropriate for installing the GP unit horizontally into the panel. Please see "GP-4201TM/4301TM Hardware Manual" about how to use the Anti-rotation Tee.

Wiring

⚠ WARNING

HAZARD OF ELECTRIC SHOCK

- When the frame ground (FG) terminal is connected, verify the wire is grounded. Not grounding the unit can result in excessive Electromagnetic Interference (EMI). Grounding is required to meet EMC level immunity.
- Remove power before wiring to the power terminals of the unit.
- The unit uses only 24 Vdc power. Using any other level of power can damage both the power supply and the unit.
- Since there is no power switch on the GP unit, be sure to attach a breaker-type switch to its power cord.

Failure to follow these instructions can result in death, serious injury, or equipment damage.

NOTE: The shield ground (SG) and FG terminals are connected internally in the unit.

1. Power Cord Specifications

Use copper conductors only.

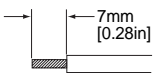
Power Cord Diameter	0.75 to 2.5mm ² (18 - 12AWG)
Conductor type	Simple or Stranded Wire ^{*1}
Conductor Length	

- *1. If the Conductor's end (individual) wires are not twisted correctly, the end wires may either short against each other, or against an electrode.

2. Power Connector Specifications

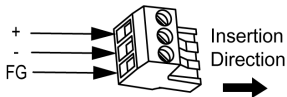

Connection	Wire
+	24 V
-	0 V
FG	Grounded terminal connected to the unit chassis.

3. How to Connect the Power Cord

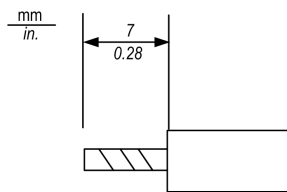
Step	Action
1	Remove the power cord from the power supply.
2	Remove the DC power connector from the unit.
3	Remove 7 mm (0.28 in.) of the vinyl cover of each of the power cord wires. 
4	If using stranded wire, twist the ends. Tinning the ends with solder reduces the risk of fraying and enhances electrical transfer.
5	Connect the wires to the power plug by using a flat-blade screwdriver (Size 0.6 x 3.5).
6	Torque the mounting screws: 0.5 to 0.6 N•m (4.4 to 5.2 lb-in).
7	Replace the DC power connector to the terminal connector.

NOTE: Do not solder the wire directly to the power receptacle pin.

4. Wiring Cautions

Improving Noise/Surge Resistance

- The GP unit's power supply cord should not be bundled with or kept close to main circuit lines (high voltage, high current), power lines, or input/output lines, and their various systems should be kept separate. When power lines cannot be wired via a separate system, use shielded cables for input/output lines.
- Make the power cord as short as possible, and be sure to twist the ends of the wires together (i.e. twisted pair cabling) from close to the power supply unit.
- If there is an excess amount of noise on the power supply line, connect a noise reducing transistor before turning on the power.
- Connect a surge absorber to handle power surges. Be sure to ground the surge absorber (E1) separately from the GP unit (E2).

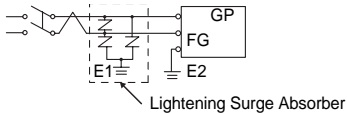

Short Circuit Prevention

- The SG (signal ground) and FG (frame ground) terminals are connected internally in the GP unit. When connecting the SG line to another device, be sure that no shorting loops are formed.

Grounding

- Use an exclusive grounding wire with a grounding resistance of 100Ω or greater and a wire of 2mm^2 or thicker, or your country's applicable standard.

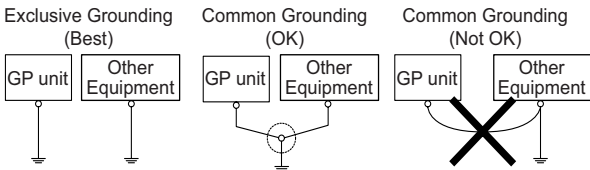

USB Clamp

When using a USB device, you can attach a USB clamp to the USB interface to prevent the USB cable from being disconnected.

⚠ WARNING

RISK OF EXPLOSION IN HAZARDOUS LOCATIONS

In hazardous locations as described in ANSI/ISA - 12.12.01:

- confirm that the USB cable has been attached with the USB cable clamp before using the USB host interface.
- remove power before attaching or detaching any connector(s) to or from the unit.

Failure to follow these instructions can result in death, serious injury, or equipment damage.

1. Attaching the USB Clamp

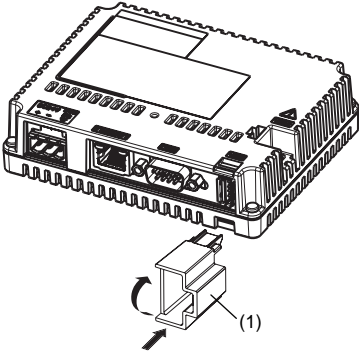
Step	Action
1	<p>Attach the USB holder to the USB Host Interface on the rear module. Hook the upper pick of the USB holder to the attachment hole of the main unit, and insert the lower pick as shown below to fix the USB holder.</p>  <p>(1) USB Holder</p>

2

Insert the USB cable into the USB host interface.

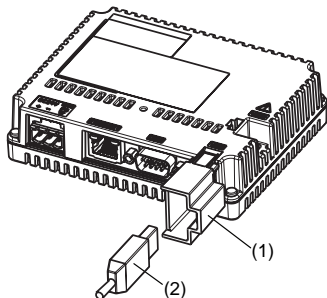

- (1) USB Holder
- (2) USB Cable

3

Attach the USB cover to fix the USB cable in place. Insert the USB cover into the tab of the USB holder.

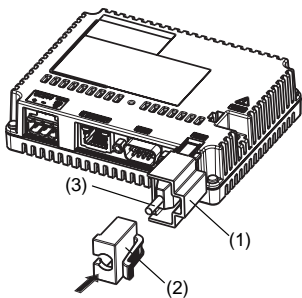

- (1) USB Holder
- (2) USB Cover
- (3) USB Cable

2. Removing the USB Clamp

1

Push down the tab of the USB holder and then remove the USB cover.

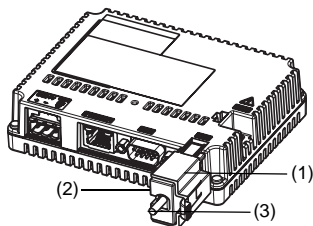

- (1) USB Holder
- (2) USB Cover
- (3) USB Cable

Relevant Standards

GP-4201TM and GP-4301TM are manufactured in accordance with:

- Standard UL 508 and CSA C22.2 n°142 for Industrial Control Equipment
- UL1604, ANSI/ISA - 12.12.01 and CSA C22.2 n°213 for Electrical Equipment for Use in Class I, Division 2 Groups A, B, C and D Hazardous (classified) Locations

NOTE:

- For use in Pollution Degree 2 environments.
- For use on a flat surface of Type 4X (Indoor Use Only) Enclosure.

WARNING

RISK OF EXPLOSION IN HAZARDOUS LOCATIONS

- Verify the power, input, and output (I/O) wiring are in accordance with Class I, Division 2 wiring methods.
- Do not substitute components that impair compliance to Class I, Division 2.
- Do not connect or disconnect equipment unless power has been switched off or the area is non-hazardous.
- Do not disconnect while circuit is live.
- Securely lock externally connected units and each interface before turning on the power supply.
- The USB2 connector is for temporary connection only during maintenance and setup of the device. Do not use, connect, or disconnect USB2 cable unless area is known to be non-hazardous.
- Potential electrostatic charging hazard: wipe the front panel of the terminal with a damp cloth before turning ON.

Failure to follow these instructions can result in death, serious injury, or equipment damage.

CAUTION

ENVIRONMENTAL HAZARDS TO THE EQUIPMENT

- Allow the device to reach the surrounding air temperature, not exceeding 50°C (122°F), before turning the device on.
- Do not turn on the device if condensation has occurred inside the device. After it is completely dry again, the device may be turned on.
- Do not expose the device to direct sunlight.
- Do not obstruct the vents in the device casing.
- Remove any dust from the device before turning it on.
- Ensure that the cable installation fasteners are not damaged. Replace them, if necessary.

Failure to follow these instructions can result in injury or equipment damage.

GP-4201TM and GP-4301TM must be installed, used and maintained in accordance with:

- Standard WEEE, Directive 2002/96/EC
- Standard RoHS, Directive 2002/95/EC
- Standard RoHS China, Standard SJ/T 11363-2006

NOTE

Please be aware that Digital Electronics Corporation shall not be held liable by the user for any damages, losses, or third party claims arising from the uses of this product.

Digital Electronics Corporation
8-2-52 Nanko-higashi
Suminoe-ku, Osaka 559-0031
JAPAN
TEL: +81-(0)6-6613-3116
FAX: +81-(0)6-6613-5888
<http://www.pro-face.com>

The information in this document is subject to change without notice.
©Copyright 2011 Digital Electronics Corporation. All rights reserved.

