

**m** **Gard** Trapped Key Technology

**am** **Gard** Safety Gate Switch Interlocks

**e** **Gard** Total Access & Control



# Product Catalogue

Total Access & Control

## “Who we are”

A market leader, Fortress Interlocks design and manufacture safety access & control systems. Fortress offer an unrivalled portfolio suitable for applications across a wide industrial base from power generation and distribution, steel, automotive, recycling, building materials, through safeguarding robots and palletisers.

With in excess of 40 years experience in the safety market, Fortress are renown for their innovative design, robust engineering and reliability.

## “What we do”

Fortress help customers protect their human and capital assets. We create safe workplaces where employees are safeguarded from injury and plant is protected from damage.

We are world leaders in access control systems, and our products guarantee that actions and events are undertaken in a pre-determined sequence ensuring a safe working environment.

## “Total Access & Control”

With the introduction of eGard, Fortress can provide “Total Access & Control”, from cost effective general duty access interlocks and simple automation control systems (eGard), to the most robust trapped key interlocks (mGard) or safety gate switches (amGard).

## “Why choose Fortress”

Fortress are a solution provider and our extensive product offering and interlocking experience allows us to provide unique solutions for all safeguarding applications. We regularly create bespoke solutions, often by customising our standard products.

# Fortress Interlocks

The designer, manufacturer  
and global supplier of Total  
Access & Control systems



NB Our brochure is designed to give an overview of our brand portfolio. For detailed technical information including 2D autocad file downloads, 3D animated product views and specific application information, visit our web site [www.fortressinterlocks.com](http://www.fortressinterlocks.com)

## Key Interlock Systems



mGard Introduction	4
Application Examples	5
Modular Components	
Power/Control Isolation	7
Key Exchange Units	10
Door Locks & Actuators	11
Accessories & Technical Specifications	12
Range Card	13



## Safety Gate Switch Interlocks



amGard Introduction	14
Application Examples	15
Modular Components	
Head Modules	16
Adaptor Modules	17
Electrical Switching/Locking	19
Option PODs	20
Technical Specifications	21
Range Card	23

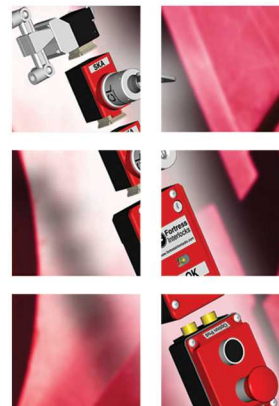

## Access & Control Systems



eGard Introduction	24
Application Examples	25
Modular Components	
Head Modules & Actuators	26
Core Modules	27
Base Modules	30
Cables & Accessories	31
Technical Specifications	32
Range Card	34

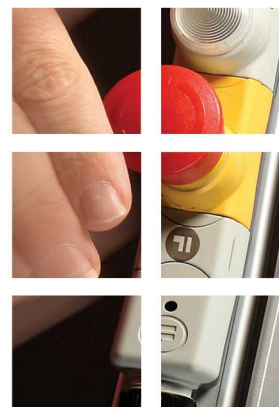



**mGard** is the premier range of modular robust trapped key interlocks for heavy duty applications. Trapped key interlocking is a tried and tested method of mechanically safeguarding dangerous machines and hazardous processes, and is suitable for category 4 (EN 954-1) applications. It is called "Trapped Key" as it works by releasing and trapping keys in a predetermined sequence. After the control or power has been isolated, a key is released that can be used to grant access to individual or multiple doors.

The principles of trapped key technology apply to all industries where it is essential that all energy sources are isolated before gaining access to machinery. Almost all safety issues can simply be solved by selecting the required products in order of the steps shown on this page.



SE-CLIN

power/control isolation

**Identify the energy sources to be isolated and/or any hazard that cannot immediately be isolated such as; heat, pressure, radiation or machine rundown time**

- |  |  |
|--|--|
| <p><b>power isolation</b></p> <ul style="list-style-type: none"> <li>• Mechanical Bolt Interlock</li> <li>• Bolt Interlock with Limit Switch</li> <li>• Bolt Interlock with Switch</li> <li>• Breaker Locks</li> </ul> | <p><b>control isolation</b></p> <ul style="list-style-type: none"> <li>• Key Switches</li> <li>• Solenoid Controlled Key Switch</li> <li>• ATEX Key Switch</li> <li>• ATEX Solenoid Controlled Key Switch</li> <li>• Solenoid Controlled Key Switch Unit</li> <li>• Electronic Time Delay Unit</li> <li>• Voltage Sensing Unit</li> <li>• Knob Operated Switch Control Unit</li> </ul> |
|--|--|



XM4-MLIN

key exchange

**Identify the type and number of access points.**

- Key Exchange Units
- Key Exchange Units with Switch

Because of the modular arrangement of mGard both key exchange and door lock units can easily be extended with an *extension module (XMA)*, for instance when doors are added to the safeguarded area or machine.

The Fortress Trapped Key System allows the safeguarding of potentially hazardous areas without the need of wiring.

All mechanical mGard configurations are suitable for use in areas where explosive or flammable gases for dust particles may be present.



DM2-S-MLIS

door locks & actuators

**Identify the type of access point; part body or full body access doors with or without the use of personal safety keys (to prevent accidental lock in).**

- Single Door Interlocks
- Multiple Door Interlocks
- Fixed actuators
- Handle actuators
- Spring loaded handle actuators
- Self aligning actuators
- Compressible actuator

For dimensional drawings please use the Datasheets/Installation Manuals at [www.fortressinterlocks.com](http://www.fortressinterlocks.com)



**mGard Application Example I (safeguarding without rundown time)**

By using a trapped key system, this mixer is safeguarded in a pre-determined sequence without the need of wiring. mGard products are very robust and ideal for use in harsh conditions, such as heat, vibration, dust and moisture.

- 1 BM1-CLIN**  
First the isolation switch is operated into a safe condition. In this "off" position it's possible to shoot the bolt of the BM1 bolt-lock to isolate the switch and release the key.
- 2 XM3-CLIN**  
The isolation key can now be inserted into the XM3 key exchange box and trapped, allowing the two access keys to be released.
- 3 DM1-CLIS-H**  
The two access keys can be inserted into the handle operated door interlocks located on the mixer, enabling the hatches to be opened for maintenance or repair purposes.

Mixer restart is only possible after reversing the sequence.

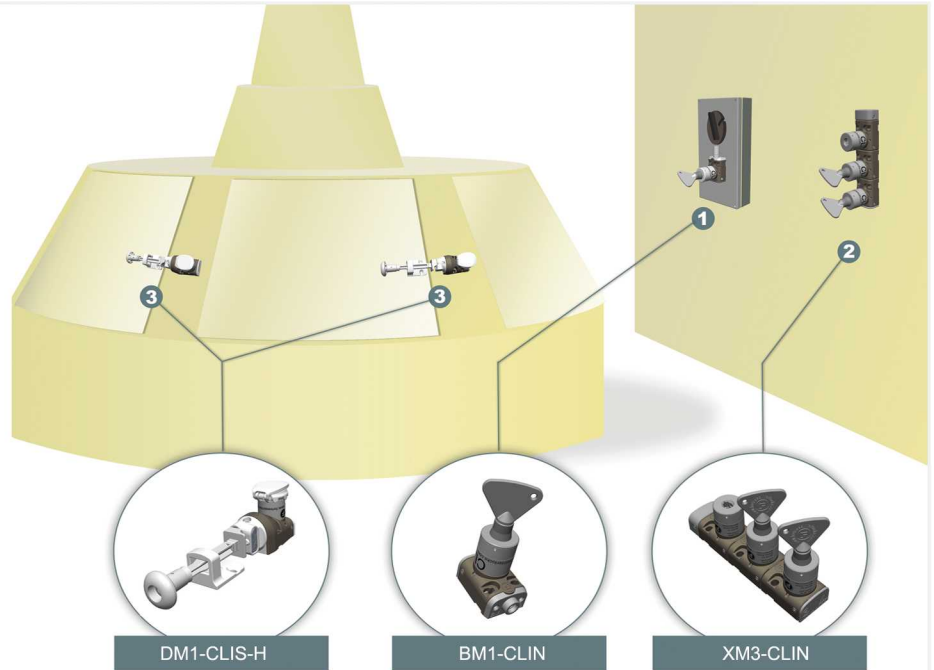

**mGard Application Example II (safeguarding with rundown time)**

This enclosed machine area is safeguarded with the use of a solenoid controlled trapped key interlock system. The modular arrangement allows configurations for virtually any safeguarding application.

- 1 SS1-CLIN-A02022D024B**  
After remote request for access and/or rundown time, the solenoid of the SS1 solenoid controlled key switch is energised releasing the key. After releasing the isolation key, the machine is isolated.
- 2 XM3-CLIN**  
The isolation key can be inserted into the XM3 key exchange box to release two access keys.
- 3 DM1-CLIN-H & DM2-CLIN-H**  
The access keys can be used to open the doors to the safeguarded area. Full body access doors are equipped with a safety key, that can be taken into the safeguarded area, to prevent accidental lock in.

Machine restart is only possible after reversing the sequence.



**mGard Application Example III (mGard linked to amGard)**

By combining the mGard range of trapped key interlocks, with the electro mechanical functions of the amGard range , additional safety features can easily be integrated to meet Category 4 (EN 954) requirements.

In this example an mGard solenoid controlled key switch unit is used to safely control the use of amGard switch controlled door locks.

- 1 SS2-CLIN-A0222D024B  
After remote request for access and/or rundown time, the solenoid of the SS2 solenoid controlled key switch is energised releasing the two keys "A". After releasing at least one of these isolation keys, the machine is isolated.

- 2 AMS1A1STOP024CLIN  
The two keys "A" can be inserted into the handle operated door locks, to access the safeguarded area.

This configuration is equipped with two additional safety functions: A Safety switch which monitors the presence of key "A" and a safety key adaptor with safety key "B" to prevent accidental lock in and/or machine restart.

SS2-CLIS-A0222D024B

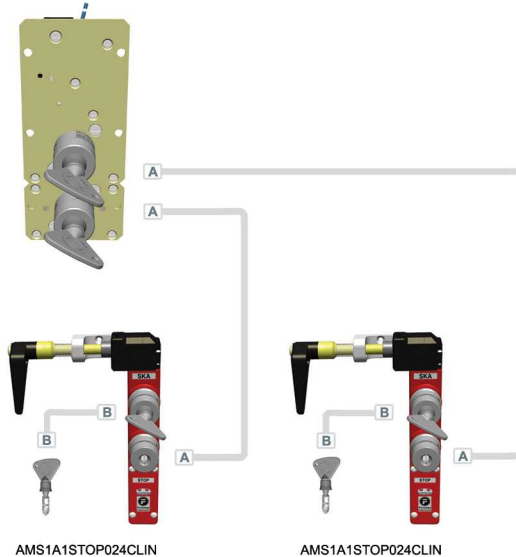

**mGard Application Example IV (electrical switch gear interlocking)**

To prevent paralleling of incoming or busbar power supplies, mGard mechanical trapped key systems are used to control safe operation.

In this application example two incoming supply isolators are fitted with BM1 bolt interlocks, that allow that only one isolator can be closed (switched "on") at any time.

Each bolt lock is equipped with a blocking device such that when the bolt is shot, the isolator cannot be closed.

Only one key is supplied with this system in order to prevent paralleling of incoming or busbar power supplies.

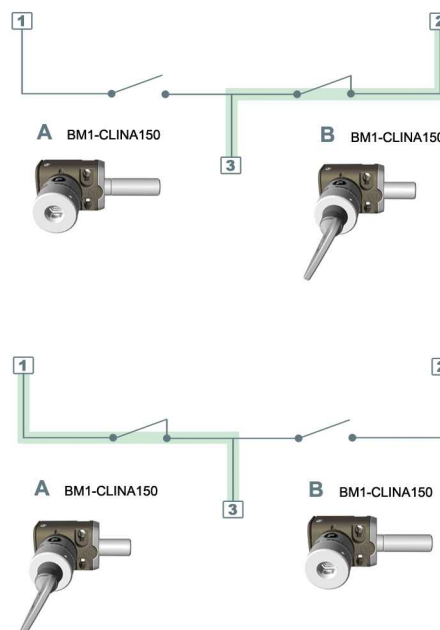

**Power Isolation**

**BM**



**Mechanical Bolt Interlock**

The BM is used to interlock circuit breakers, valves earth switches etc. It is used where hazards needs to indirectly interlocked.

- No product handling issues
- 16mm diameter bolt with 16mm of travel standard (extended bolt lengths available)
- Standard operation: Key free, bolt shot (other sequences available)

*The BM may not be used as an access lock.*

**Product Types**

N° of Locks	Ref N°
1 » 10	BM1 » BM10
N° of Locks (Full Stainless Steel)	Ref N°
1 » 5	BMS1 » BMS5
Lock Type	
For key and lock specifications view page 12	
Bolt Lengths	Ref N°
6.35mm	-
50mm extension	50
150mm extension	150

**BML**

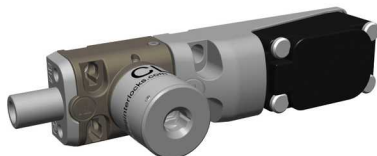

**Bolt Interlock with Limit Switch**

This device is used to interlock circuit breakers, valves, earth switches etc. It additionally provides electrical indication of the bolt position.

- No product handling issues
- 16mm diameter bolt with 16mm of travel standard (extended bolt lengths available)
- Standard operation: Key Free, bolt shot (other sequences available)
- Standard IP67 switch

*These products may not be used as an access lock.*

**Product Types**

N° of Locks	Ref N°
1 » 4	BML1 » BML4
N° of Locks (Full Stainless Steel)	Ref N°
1 » 4	BMSL1 » BMSL4
Switch AMPS	Ref N°
3A	-
Switch Contacts	Ref N°
1NO / 1NC	-
Lock Type	
For key and lock specifications view page 12	
Bolt Lengths	Ref N°
See BM specification	

**BMR**

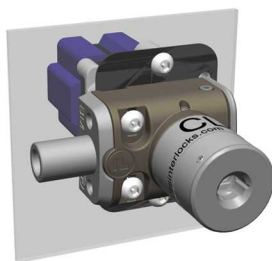

**Bolt Interlock with Switch**

This device is used to interlock circuit breakers, valves, earth switches etc. It additionally provides electrical indication of the bolt position.

- No product handling issues
- 16mm diameter bolt with 16mm of travel standard (extended bolt lengths available)
- Standard operation: Key free, bolt shot (other sequences available)
- Special switch ratings and/or contact arrangements available on request

*These products may not be used as an access lock.*

**Product Types**

N° of Locks	Ref N°
1 » 10	BMR1 » BMR10
N° of Locks (Full Stainless Steel)	Ref N°
1 » 5	BMSR1 » BMSR5
Lock type	
For key and lock specifications view page 12	
Switch AMPS	Ref N°
20A	A020
32A	A032
63A	A063
Switch Contacts	Ref N°
4NO / 0NC	40
2NO / 2NC	22
Bolt Lengths	Ref N°
6.35mm	-
50mm extension	50
150mm extension	150

**AC090AB**



**Circuit Breakers**

When mounted on the front of the circuit breaker, this lock allows or prevents switching of the breaker.

- All circuit breakers make and type must be specified

**Product Types**

Breaker Type	Ref N°
ABB (SACE EMAX)	CLIN-AC090AB
Merlin Gerin (Masterpact)	CLIN-MC090MG
Siemens (3WL)	CLIN-X002
Key Type	Ref N°
Standard	CLK-SUS
Low Profile	CLK-LP
Low Profile (Siemens)	CLK-SBS

**Bolt Interlocks**

For isolation of existing machinery or equipment, Fortress bolt interlocks are a simple mechanical solution to guarantee a safe work place, without the need for wiring. The robust design for both keys and locks can withstand harsh environments, such as dust, moisture and vibration.





**Control Isolation**

**S**

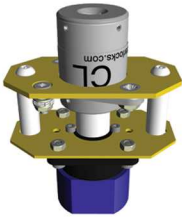



**Key Switch**

The S(E) unit is suitable for isolation or switching current and may be to isolate power to machinery.

- Direct drive operation - positively opens contacts
- The standard sequence is: Key trapped - Power on, Key free - Power off (other sequences to be specified)
- Special switch ratings and/or contact arrangements available on request
- Enclosed version (SE) in Polycarbonate (IP66) as standard

**Product Types**

<u>Mounting</u>	Ref N°
Back of Board	S
In Enclosure (IP66)	SE
<u>Lock Type</u>	
For key and lock specifications view page 12	
<u>Switch AMPS</u>	Ref N°
20A	A020
32A	A032
63A	A063
<u>Switch Contacts</u>	Ref N°
4NO / 0NC	40
2NO / 2NC	22

**SS**

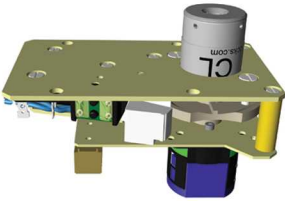



**Solenoid Controlled Key Switch**

The SS unit is used where the key(s) need(s) to remain trapped until an electronic signal has been received.

- Direct drive operation - positively opens contacts
- Suitable for machines with a rundown cycle
- The standard sequence is: Key trapped - Solenoid de-energised, Key free - Solenoid energised, (other sequences available)
- Special switch ratings, solenoid voltage and/or contact arrangements available on request
- Solenoid monitoring contacts as standard
- Enclosed version (SS-F) in Polycarbonate (IP66) as standard

**Product Types**

<u>N° of Locks</u>	Ref N°
1 » 8	SS1 » SS8
<u>Lock type</u>	
For key and lock specifications view page 12	
<u>Switch AMPS</u>	Ref N°
20A AC	A020
32A AC	A032
63A AC	A063
<u>Switch Contacts</u>	Ref N°
4NO / 0NC	40
2NO / 2NC	22
<u>Solenoid Voltage</u>	Ref N°
24V DC	D024
110V AC / 110V DC	A110 / D110
<u>Mounting</u>	Ref N°
Back of Board	B
In Enclosure (IP66)	F

**FLP**





**ATEX Key Switch**

A key switch for use in areas where explosive/flammable gases or dust particles may be present.

- Direct drive operation - positively opens contacts
- The standard sequence is: Power on - Key trapped (other sequences to be specified)
- BASEEFA (ATEX directive 94/9/EC Certification)
- EExdIIC T6 Zones 1 & 2
- Special switch ratings and/or contact arrangements available on request

**Product Types**

<u>Mounting</u>	Ref N°
In Enclosure (IP65)	FLP
<u>Lock type</u>	
For key and lock specifications view page 12	
<u>Switch AMPS</u>	Ref N°
20A	A020
32A	A032
63A	A063
<u>Switch Contacts</u>	Ref N°
4NO / 0NC	40
2NO / 2NC	22

**EEXSS1**





**ATEX Solenoid Controlled Key Switch**

A solenoid key switch for use in areas where explosive, flammable gases or dust particles may be present.

- Direct drive operation - positively opens contacts
- The standard sequence is: Power on - Key trapped - Solenoid de-energised (other sequences to be specified)
- Ex II 2 GD, EEx IIC T6 IP66 T85oC, according to CENELEC standard EN 50018 and EN 50281-1-1.
- Special switch ratings, solenoid voltage and/or contact arrangements available on request.
- Solenoid monitoring contacts as standard

**Product Types**

<u>Mounting</u>	Ref N°
In Enclosure (IP66)	EEXSS1
<u>Lock type</u>	
For key and lock specifications view page 12	
<u>Switch AMPS</u>	Ref N°
20A	A020
32A	A032
<u>Switch Contacts</u>	Ref N°
4NO / 0NC	40
2NO / 2NC	22
<u>Solenoid Voltage</u>	Ref N°
24V DC	D024
110V AC / 110V DC	A110 / D110

**Solenoid Controlled Key Switch**

The device is used where the key(s) need(s) to remain trapped until an electronic signal has been received. (e.g. for machine rundown time or cycle end)



**SLS**



**Solenoid Controlled Key Switch Unit**

This device ensures that keys may not be released until both the solenoid has been energised and the control power has been isolated.

- Suitable for machines with a rundown cycle
- Fortress key operated override facility for mechanical release of the keys
- LED status indication

**Product Types**

N° of Locks (excl. override lock)	Ref N°
1 » 6	SLS1 » SLS6
<b>Lock type</b>	
For key and lock specifications view page 12	
Switch AMPS	Ref N°
10A	A010
Switch Contacts	Ref N°
2NO / 2NC	22
Solenoid Voltage	Ref N°
24V DC	D024
110V AC / 110V DC	A110 / D110

**ET**



**Electronic Time Delay Unit**

The ET unit releases keys at the end of a pre-determined time period.

- Direct drive operation - positively opens contacts
- Suitable for machines with a rundown cycle
- Enclosures in Polycarbonate (IP65) as standard
- Special switch ratings, solenoid voltage and/or contact arrangements available on request
- Solenoid monitoring contacts as standard
- Remotely (ETR) and knob operated (ETS) version available on request

**Product Types**

N° of Locks	Ref N°
1 » 3	ET1 » ET3
<b>Lock type</b>	
For key and lock specifications view page 12	
Switch AMPS	Ref N°
20A	A020
32A	A032
63A	A063
Switch Contacts	Ref N°
4NO / 0NC	40
2NO / 2NC	22
Solenoid Voltage	Ref N°
24V DC	D024
110V AC / 110V DC	A110 / D110
Time Delay Up To	Ref N°
5 Min	05
30 Min	30

**VS**



**Voltage Sensing Unit**

Releases key(s) after zero voltage detection of the BEMF.

- Direct drive operation - positively opens contacts
- Suitable for machines with a rundown cycle
- Enclosures in Polycarbonate (IP65) as standard
- Special switch ratings, solenoid voltage and/or contact arrangements available on request
- Solenoid monitoring contacts as standard

**Product Types**

N° of Locks	Ref N°
1	VS1
<b>Lock type</b>	
For key and lock specifications view page 12	
Solenoid Voltage	Ref N°
24V AC	024
110V AC	110
230V AC	230

- ODS** Knob operated
- ODL** Key operated

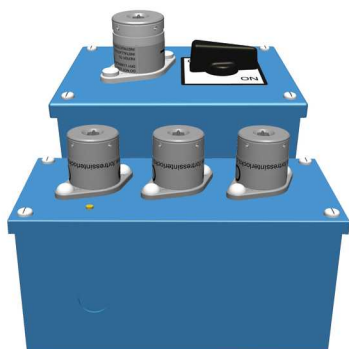

**Knob Operated/Key Operated Switch Control Unit**

The ODS Releases key(s) after switching the knob into a visible off position.

The ODL is a 'key bank' with a switch. It incorporates one or more rotary switches and any combination of trapped or freed keys.

- Direct drive operation - positively opens contacts
- Mild steel enclosure as standard
- Stainless steel enclosure as standard in combination with CLSS or MLSS lock types
- Special switch ratings and/or contact arrangements available on request

**Product Types**

Operation Type	Ref N°
Knob operated	ODS
Key operated	ODL
N° of Locks Released or Trapped	Ref N°
1 » 8	OD(S/L)1 » OD(S/L)8
<b>Lock type</b>	
For key and lock specifications view page 12	
Vertical/Horizontal	Ref N°
Vertical	V1
Horizontal	H1
Linking System	Ref N°
Cams (stainless steel)	C(S)
Runnerbar (stainless steel)	R(S)
Mounting	Ref N°
Back of Board	B
In Enclosure	F
Switch AMPS	Ref N°
20A	A020
32A	A032
63A	A063
150A	A150
Switch Contacts	Ref N°
4NO / 0NC	40
2NO / 2NC	22

**Key Exchange**

**XM**



**Modular Key Exchange Unit**

The XM unit is used to exchange one or more keys for a number of other keys. This device forms the link between isolation devices and access locks.

- No product handling issues
- Any combination of isolation/access keys possible
- Sequential or Non-sequential key operation
- Simply add modules to existing configurations

**Product Types**

N° of Locks	Ref N°
1 » 10	XM1 » XM10

N° of Locks (Full Stainless Steel)	Ref N°
1 » 5	XMS1 » XMS5

Lock type

For key and lock specifications view page 12

**XMR**

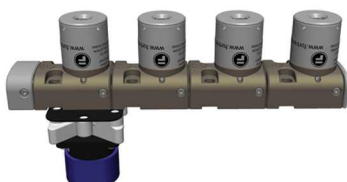

**Modular Key Exchange Unit with Switch**

Besides exchanging one or more keys for a number of other keys the XMR is additionally fitted with rotary switch(es) that can be used for power or control isolation.

- No product handling issues
- Any combination of isolation/access keys possible
- Sequential or Non-sequential key operation
- Simply add modules to existing configurations
- Enclosed version (XMR-E) in Polycarbonate (IP67) as standard

**Product Types**

N° of Locks	Ref N°
1 » 10	XMR1 » XMR10

N° of Locks (Full Stainless Steel)	Ref N°
1 » 5	XMSR1 » XMSR5

Lock type

For key and lock specifications view page 12

Switch AMPS	Ref N°
20A	A020
32A	A032
63A	A063

Switch Contacts	Ref N°
4NO / 0NC	40
2NO / 2NC	22

Mounting	Ref N°
Sealed Enclosure (IP67)	-E
Back of Board	-P

**Door Locks**

**DM1**



**Single Door Interlock**

- No product handling issues:  
*4 head rotation angles with an adjustment of 360° at 90° increments with +/- 5° fine adjustment*  
*Two actuator entry points*

- All DM locks have stainless steel heads
- Tamper resistant head mechanism
- Choice of actuators

**Product Types**

N° of Locks	Ref N°
1	DM1

N° of Locks (Full Stainless Steel)	Ref N°
1	DMS1

Lock type

For key and lock specifications view page 12

**DM**



**Multiple Modular Door Interlock**

- No product handling issues:  
*4 head rotation angles with an adjustment of 360° at 90° increments with +/- 5° fine adjustment*  
*Two actuator entry points*

- Any combination of isolation/access keys possible
- Sequential or Non-sequential key operation
- Simply add modules to existing configurations
- All DM locks have stainless steel heads
- Tamper resistant head mechanism
- Choice of actuator

**Product Types**

N° of Locks	Ref N°
2 » 10	DM2 » DM10

N° of Locks (Full Stainless Steel)	Ref N°
2 » 5	DMS2 » DMS5

Lock type

For key and lock specifications view page 12



**DM Handing Options**

The DM and DMS modules benefit from a revolutionary new patented head design. With 5 actuators to choose from, the head features a choice of 4 head rotation angles and 2 actuator entry points with an adjustment of 360° at 90° increments with +/- 5° fine adjustment



**Actuators**

**Fixed Actuator**

**DM-F** \* is displayed as -F in part N°



- For use with all DM type locks
- Ideal for most aligned guarding doors
- Compact (fits within DM body's space envelope)
- Version with chain available (DM-F-chain)

**Handle Actuator**

**DM-H** \* is displayed as -H in part N°



- For use with all DM type locks
- Suitable for use where secondary action is required *to overcome misalignment to prevent lock damage by slamming doors*
- Vertical adjustment: +/- 6mm
- Rotational adjustment of bracket

**Spring Operated Handle Actuator**

**DM-A** \* is displayed as -A in part N°



- For use with all DM type locks
- Suitable for use where secondary action is required *to overcome misalignment to prevent lock damage by slamming doors*
- Detent holds actuator in place when door is open
- Vertical adjustment: +/- 6mm
- Rotational adjustment of bracket

**Self Aligning Actuator**

**DM-S** \* is displayed as -S in part N°



- For use with all DM type locks
- Ideal for small radius hinged doors
- Horizontal adjustment: +/- 7.50mm
- Vertical adjustment: +/- 3.75mm
- Rotational adjustment: any angle in 360°

**Compressible Actuator**

**DM-C** \* is displayed as -C in part N°

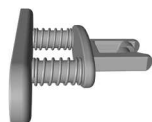

- For use with all DM type locks
- Ideal to absorb vibration on hatches/doors
- Can be used on small radius hinged doors
- Suitable for situations where the door is likely to be slammed

**Accessories**

**XMA**



**Extension Module**

- For adding lock units onto existing BM, BMR, XM, XMR, DM and DMR configurations

**Product Types**

Housing Material	Ref N°
Standard	XMA
Full Stainless Steel	XMSA

Lock type  
For key and lock specifications view page 12

**MBOB**



**Back of Board Mounting Kit**

- To provide back of board mounting possibilities for BM, BMR, XM, XMR, DM and DMR configurations

**Product Types**

Housing Material	Ref N°
Standard	MBOB









*Not suitable for use onto full stainless steel configurations*

**Lock and Key Specifications**

Fortress locks have over 200,000 different lock combinations. Besides the standard basic (CL) it also is also possible to have a master series (ML) which can be operated by a special cut master key (MLK-SUGS) that fits on any mastered lock in a specific mastered lock series. For ease of use all Fortress locks provide key insertion in two directions.

**Lock and key engravings**

Each different key combination is allocated with an engraved code onto the lock and key, of up to maximum 30 characters (3 lines of 10 characters), this engraving code is used to identify locks and keys and is recorded in a database for continuous cross reference. Required engravings are therefore to be provided with each order.

Standard	 <b>CLIN lock</b> Standard CL lock no dustcover	 <b>CLIS lock</b> Standard CL lock with stainless steel dustcover	 <b>CLSS lock</b> Full Stainless Steel CL lock with stainless steel dustcover	 <b>CLK-SUS</b> Standard key for use on all CL lock types	
	Master	 <b>MLIN lock</b> Masterable ML lock no dustcover	 <b>MLIS lock</b> Masterable ML lock with stainless steel dustcover	 <b>MLSS lock</b> Full Stainless Steel masterable ML lock with stainless steel dustcover	 <b>MLK-SUGS</b> Standard cut key for use on all ML type locks
					 <b>MLK-SUCM</b> Master cut key for use on all ML lock types

As an option Fortress locks can also be supplied with Padlockable dustcovers, that incorporates two padlock holes which can be fitted with lockout hasps and scissor hasps between 3mm and 8mm in diameter as shown below.

Dustcover Options	 <b>CLDC</b> Stainless Steel Dustcover	 <b>LOH3</b> Lock-Out Hasp	 <b>LOS3</b> Lock-Out Scissor Hasp
	 <b>PLDC</b> Stainless Steel Padlockable Dustcover	 <b>LOH3C</b> Lock-Out Hasp c/w Cable	 <b>LOS3C</b> Lock-Out Scissor Hasp c/w Cable
			

Key and lock engravings



Maximum 30 characters (3 lines of 10 characters)

Power Isolation

Mechanical Bolt Interlock



- BM** BM1 » BM10 (Standard)
- BMS** BMS1 » BMS5 (Full Stainless Steel)

Bolt Interlock with Limit Switch



- BML** BML1 » BML4 (Standard)
- BMSL** BMSL1 » BMSL4 (Full Stainless Steel)

Bolt Interlock with Switch

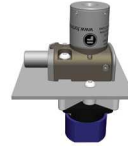

- BMR** BMR1 » BMR10 (Standard)
- BMSR** BMSR1 » BMSR5 (Full Stainless Steel)

Circuit Breakers



- CLIN-AC090AB** ABB (SACE EMAX)
- CLIN-MC090MG** Merlin Gerin (Masterpact)
- CLIN-X002** Siemens (3WL)

Control Isolation

Key Switch

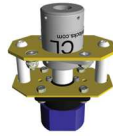

- S** Back of Board
- SE** In Enclosure

Solenoid Controlled Key Switch

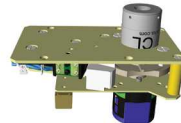

- SS-B** SS1-B » SS8-B (Back of Board)
- SS-F** SS1-F » SS8-F (In Enclosure)

ATEX Key Switch



- FLP** In Enclosure

ATEX Solenoid Controlled Key Switch



- EEXSS1** In Enclosure

Solenoid Controlled Key Switch Unit



- SLS** SLS1 » SLS6

Electronic Time Delay Unit



- ET** ET1 » ET3 (In Enclosure)

Voltage Sensing Unit



- VS** In Enclosure

Knob Operated Switch Control Unit



- ODS** ODS1 » ODS8 (In Enclosure)

Key Operated Switch Control Unit

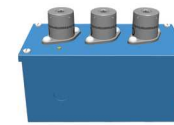

- ODL** ODL1 » ODL8 (In Enclosure)

Key Exchange

Modular Key Exchange Unit



- XM** XM1 » XM10 (Standard)
- XMS** XMS1 » XMS5 (Full stainless steel)

Modular Key Exchange Unit with Switch(es)



- XMR** XMR1 » XMR10 (Standard)
- XMSR** XMSR1 » XMSR5 (Full stainless steel)

Accessories

Extension Module



- XMA** Standard
- XMSA** Full Stainless Steel

Back of Board Mounting Kit



- MBOB**

Dustcovers



- CLDC** Stainless Steel Dustcover
- PLDC** Padlockable Dustcover

Lock-Out Hasps



- LOH3**
- LOH3C** c/w cable



- LOS3** Scissor hasp
- LOS3C** Scissor hasp c/w cable

Door Locks

Single Door Interlock



- DM1** Standard
- DMS1** Full Stainless Steel

Multiple Modular Door Interlock



- DM** DM2 » DM10 (Standard)
- DMS** DMS2 » DMS5 (Full Stainless Steel)

Actuators

Fixed Actuator



- DM-F**

Handle Actuator



- DM-H**

Handle Actuator (spring)



- DM-A**

Self Aligning Actuator



- DM-S**

Compressible Actuator

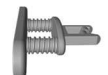

- DM-C**



**amGard** is the ultimate range of modular safety gate switch interlocks, for heavy duty applications. Its modular construction allows easy configuration. amGard provides total electro-mechanical solutions for practically any safeguarding application.

By its unique design concept, amGard offers a fully integrated safety switch controlled closing and/or locking system, designed for strength and reliability in hazardous operating conditions.

The amGard system replaces all adaptations normally fitted within a guarding system. Additional arrangements like actuators/operators, catches, internal release functions, trapped key functions and deadlocks are no longer needed. All of these separate functions are or can simply be incorporated into the amGard configurations



**Select and Configure your Solutions**

The basic assemblies ATSTOP, ATLOK and AMSTOP, AMLOK are only a selection of the configurations to suit basic heavy duty safety gate switch requirements. By selection of optional modules these configurations can easily be extended with the required functions.

amGard composes dual channel safety circuits to allow cross monitoring, the robust stainless steel actuator with a self-adjusting operation provides a long life cycle and reduction of down time and maintenance. Suitable for category 4 (EN 954-1) applications the amGard range is ideal for use in harsh environments and is tested to over 1,000,000 operations.

AmGard trapped key modules are fully interchangeable with the Fortress mGard range of trapped key interlocks.

amGard Application Example I

This example shows the safeguarding of robot areas in which amGard products offer a combined mechanical and electrical solution.

1 CPS2LOK024024B CLIN

By pressing the access request button, the machine or installation is shut down.

The solenoid lock restricts the release of keys A until the guarded area or machine is safe to enter (indicated by the yellow status LEDs).

Both safety keys A can now be released indicated by the red status LED.

2 AM & SBNS1A1FOOT CLIN

Keys A can be used to unlock the door locks and releases the safety keys B. These can be taken inside the guarded area to prevent personnel being trapped and/or an accidental machine restart.

By reversing this compulsory procedure the machine can safely be restarted.

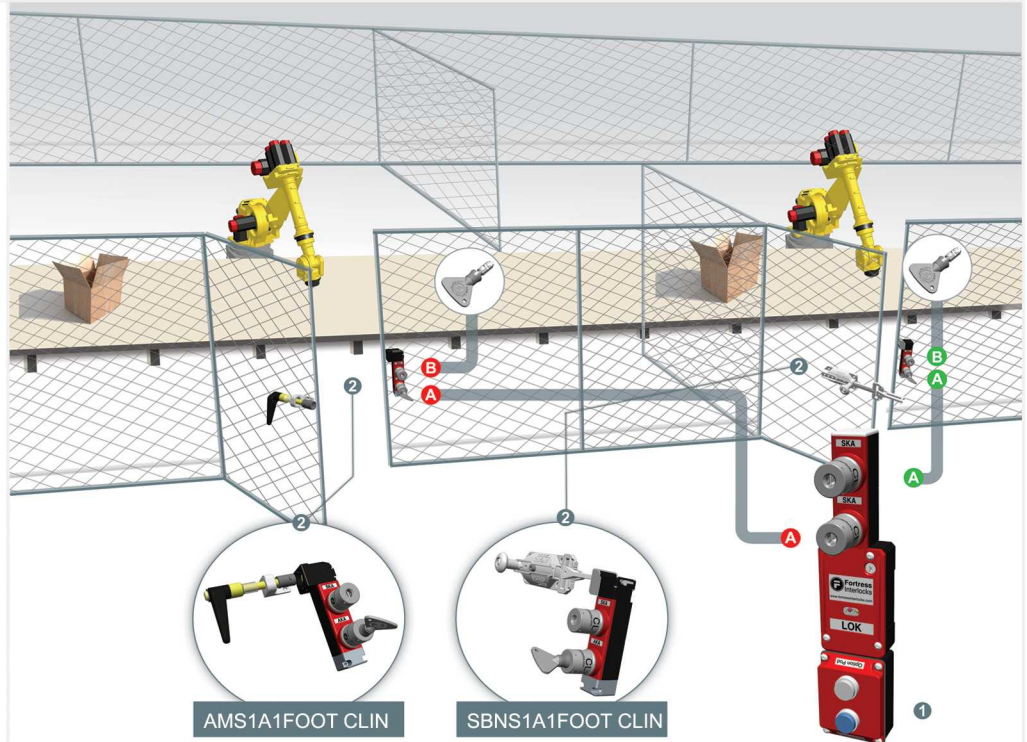

AMS1A1FOOT CLIN



SBNS1A1FOOT CLIN

amGard Application Example II

This example shows the safeguarding of a potentially dangerous area with a teach mode function inside.

1 SBNLOK024024K CLIN

Removal of the key from one of the pods at the doors selects machine stop at the end of a run down cycle. The solenoid is then energised and access can be gained.

The operator can take the safety key into the potentially hazardous area preventing restart.

2 PODK CLIN

By inserting one of the keys in the stand alone pod inside the guarded area safe programming can be initiated

3 SBILOK024024IRK CLIN

The LOK internal release option can be used to unlock the door from inside a guarded area should personnel become trapped; by pushing the button on the rear of the unit the tongue is released from the actuator head and the door can be opened from the inside.

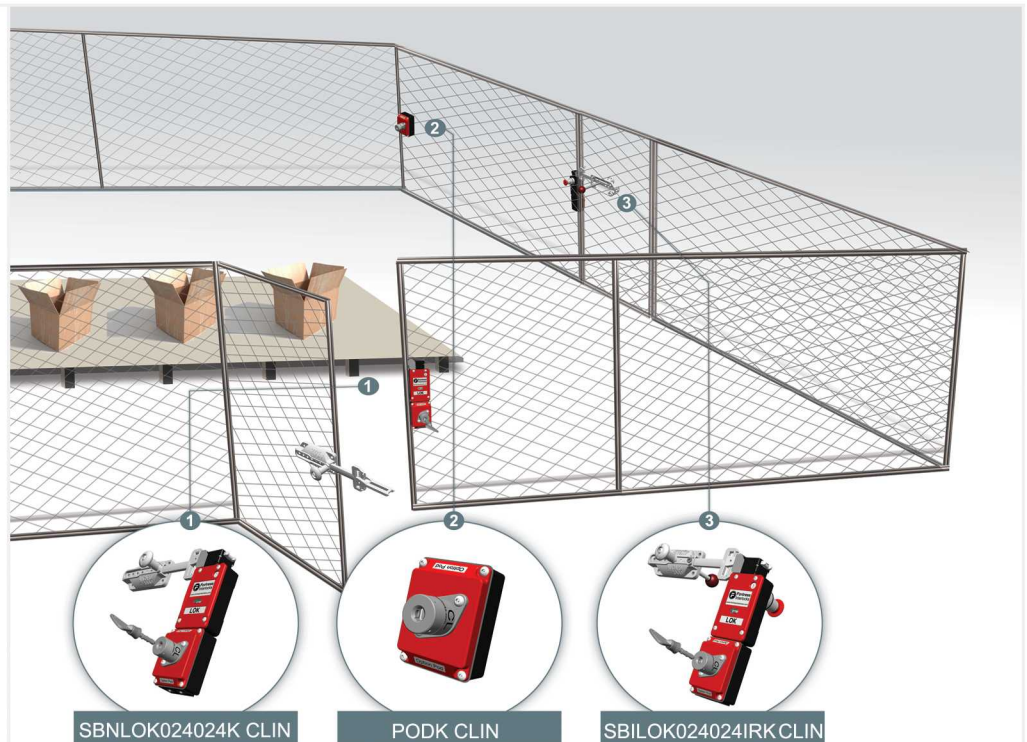

SBNLOK024024K CLIN



PODK CLIN



SBILOK024024IRK CLIN



**Head Modules & Actuators**

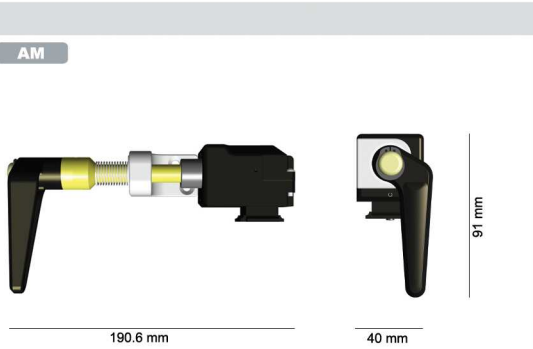

**AM Handle Actuator & Head**

- Heavy duty handle unit
- 4 position fixing at 90° increments
- Operating handle can be rotated in 45° increments
- Allows for guard misalignment
- Retention force 2500N
- Can be fitted with lock-out devices for additional safety

*Head (AMH) and Handle (AMK) also available separately.*

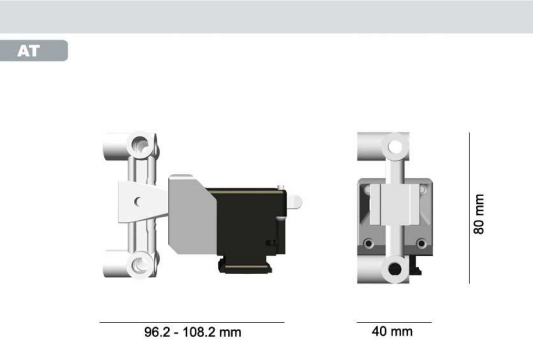
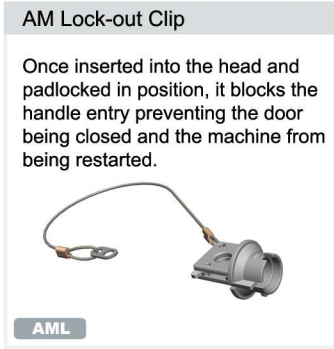

**AT Tongue Actuator & Head**

- Heavy duty tongue unit
- Ideal for fast, frequent access
- 4 position fixing at 90° increments
- Misalignment tolerance of +/- 12mm
- Retention force 2500N
- Can be fitted with lock-out devices for additional safety

*Head (ATH) and Tongue (ATK) also available separately.*

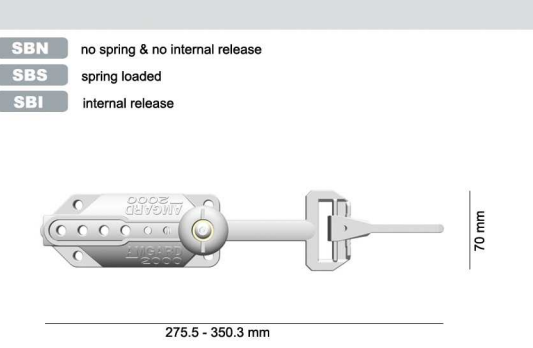
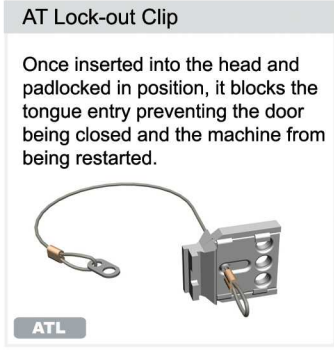

**Slidebar**

- Used in conjunction with the "ATH head"
- Particular useful for applications using small radius, hinged doors
- Stainless steel casting
- Built in lock-out facility to accommodate a maximum of 4 padlocks with up to 8 mm diameter shackles

*Spring loaded version (SBS) is advised when exposed to vibration*

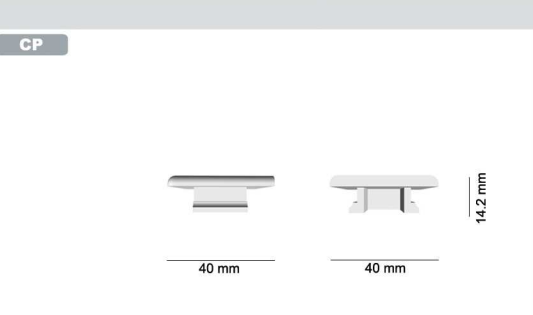

**Cap**

Suitable for use with the adaptor products

- Protects the unit from debris
- Removable to enable reconfiguration

**Hinged door equipped with SBISTOP024 configuration**





**Adaptors**

**IRA**

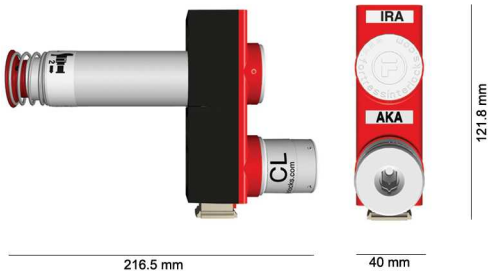

**Internal Release Adaptor**

Overrides the safety or access key mechanism and provides a means of escape from inside the guarded area.

- If incorporated into a STOP body the internal release mechanism puts the machine into a stop.
- Always in combination with A1, S1, LO or LT
- Up to 5 key adaptors in one configuration

*Cannot be used in combination with LOK type bodies.*

**S1**

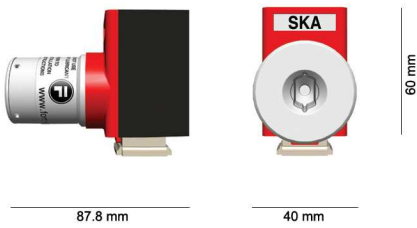

**Safety Key Adaptor**

This unit ensures that machine/process cannot be restarted without returning the key(s). It can furthermore prevent personnel being accidentally locked inside a guarded area.

- Can be stacked or combined with other adaptors
- Provides unique link to mGard range
- Up to 5 key adaptors (S1»S5) in one configuration

*For key and lock specifications view page 22. Keys must be ordered separately.*

**A1**

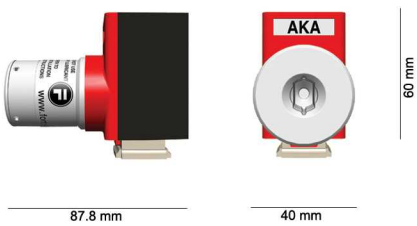

**Access Key Adaptor**

Ideally suited for authorised access only, or linked access to other machinery.

- Ensures a specific sequence of operation
- Can be stacked or combined with other adaptors
- Provides unique link to mGard range
- Up to 5 key adaptors (A1»A5) in one configuration

*For key and lock specifications view page 22. Keys must be ordered separately.*

**amGard Application Example III**

**Safeguarding an area where there is no fencing (e.g. an area protected by a light curtain) or, the guarding has mechanical door locks.**

This amGard configuration enables personnel to safely work inside potentially dangerous areas (CPS3LOK02024B CLIN). When no fencing personnel always remains responsible for their own safety and the possession of the safety key is their safety guarantee.

Access is requested by pressing the red button on the Option POD module. When the area is safe to enter, the solenoid controlled safety switch is energised and the safety keys can be released in a random order. Personnel can keep these keys with them, to prevent machine restart, or use these to open the mechanical door locks (in case of a fenced area). Only when all keys are back in the safety key adaptors the machine can be restarted.



Single Lock-Out Padlock Adaptor

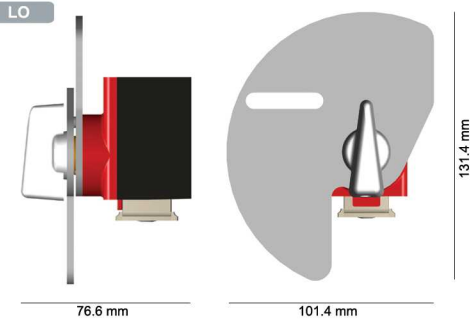

Provides padlocking only in the ON position (e.g. to prevent machine shut down).

- Provides a link with other lock-out tag-out safety procedures
- Accommodates up to 5 padlocks with 7.5mm diameter shackles
- Facilitates enhanced supervisor security

Dual Lock-Out Padlock Adaptor

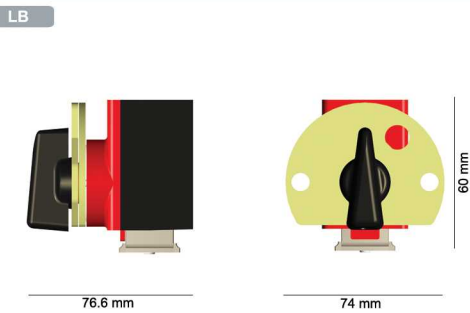

This unit is equipped with two padlock positions for use as a voluntary lock-out facility.

- Provides a link with other lock-out tag-out safety procedures
- Accommodates one padlock with 8mm diameter shackles
- Enables quick and easy access

Foot

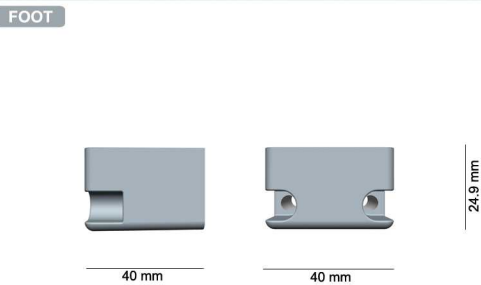

To terminate all non-switch configurations.

- Secures unit firmly to mounting surface
- Removable to allow for modification

amGard Application Example IV

ATIRA1STOP024 MLIS, a tongue operated safety switch with internal release function and access key to be inserted to safely enter the guarded area.

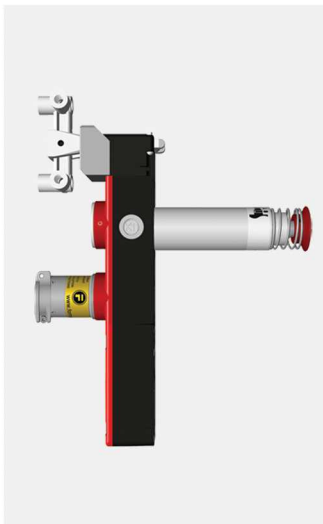

**Electrical Switching/Locking**

Base units are the electromechanical elements of the heavy duty modular amGard range that interface with safety relays and PLC's providing controlled access to machinery or a guarded area. Tested to over 1 million operations these units contain dual channel safety circuitry making them suitable for Category 4 (EN 945-1) applications.

**STOP**



40 mm      40 mm

100 mm

**Safety Switch Body**

The STOP unit breaks the dual safety circuits to select machine stop and/or monitoring access.

- Ideal for quick access to machines with no or short run-down cycles
- Non-solenoid controlled
- LED indicators for status identification

*STOP AS-i is supplied in a LOK size housing type.*

**Product Types**

Control	Ref N°
24V AC/DC	STOP024
48V AC/DC	STOP048
110V AC	STOP110
230V AC	STOP230
AS-Interface	STOPASI

**LOK** power to unlock  
**LOKPL** power to lock



43 mm      80 mm

130 mm

**Solenoid Controlled Lock Body**

Energizing (LOK) or de-energizing (LOKPL) the solenoid breaks the dual safety circuits to prevent access until machine/area is safe.

- Ideal for machines with run-down cycles
- LED indicators for status identification
- Solenoid override facility for increased safety in the event of power failure (not applicable for the power to lock version)
- Split voltage available on request

**Product Types**

Control / Solenoid	Ref N° LOK
24V AC/DC / 24V AC/DC	LOK024024
48V AC/DC / 48V AC/DC	LOK048048
110V AC / 110V AC	LOK110110
230V AC / 230V AC	LOK230230
Control / Solenoid	Ref N° LOKPL
24V AC/DC / 24V AC/DC	LOK024024PL
48V AC/DC / 48V AC/DC	LOK048048PL
110V AC / 110V AC	LOK110110PL
230V AC / 230V AC	LOK230230PL
AS-I "power to unlock"	LOKASI
AS-I "power to lock"	LOKASIPL

**LOKIR** power to unlock  
**LOKPLIR** power to lock



102.8 mm      80 mm

130 mm

**Solenoid Safety Switch with Internal Release**

This unit is equipped with an additional internal release button for a mechanical override function of the solenoid switch.

- LED indicators for status identification
- Prevents access until machine is safe
- Solenoid override facility for increased safety in the event of power failure (not applicable for the power to lock version)
- Split voltage available on request

**Product Types**

Control / Solenoid	Ref N° LOKIR
24V DC / 24V DC	LOK024024IR
48V AC/DC / 48V AC/DC	LOK048048IR
110V AC / 110V AC	LOK110110IR
230V AC / 230V AC	LOK230230IR
Control / Solenoid	Ref N° LOKPLIR
24V DC / 24V DC	LOK024024PLIR
48V AC/DC / 48V AC/DC	LOK048048PLIR
110V AC / 110V AC	LOK110110PLIR
230V AC / 230V AC	LOK230230PLIR
AS-I "power to unlock"	LOKASIIR
AS-I "power to lock"	LOKASIPLIR

**STOPTX** ATEX certified  
**STOPXP** UL/CSA certified



72.9 mm      76 mm

171 mm

**Explosion Protected Safety Switch Body**

**STOPTX** : ATEX certified product. Heavy duty explosion protected safety gate switch. Suitable for zone 1 & 2 environments

**STOPXP** : UL / CSA certified product. Heavy duty explosion protected safety gate switch. Suitable for zone 1 & 2 environments



**Option PODs**

Option PODs provide an added control feature for assembled amGard units. There are 3 standard types, each serving a specific purpose. Other combinations are available on request.

PODK	Key switch Option POD	Product Types										
	<p>The removal of the key enables the machine to stop at the end of a rundown cycle. The PODK can additionally be used separately for teach mode activation.</p> <ul style="list-style-type: none"> <li>• Contains 2NO/2NC contact arrangement</li> <li>• Switch rating 3A</li> <li>• Prevents inadvertent re-start and/or provides a request to stop/start</li> <li>• Can be used as a “stand alone” key switch</li> </ul> <p><i>For key and lock specifications view page 22. Keys must be ordered separately.</i></p>	<table border="1"> <thead> <tr> <th>Description</th> <th>Ref N°</th> </tr> </thead> <tbody> <tr> <td>Stand alone</td> <td>PODK</td> </tr> <tr> <td>For mounting to LOK module</td> <td>LOKPODK</td> </tr> <tr> <td>Mounted to LOK module</td> <td>K</td> </tr> <tr> <td>AS-Interface</td> <td>PODKASI</td> </tr> </tbody> </table>	Description	Ref N°	Stand alone	PODK	For mounting to LOK module	LOKPODK	Mounted to LOK module	K	AS-Interface	PODKASI
		Description	Ref N°									
Stand alone	PODK											
For mounting to LOK module	LOKPODK											
Mounted to LOK module	K											
AS-Interface	PODKASI											

PODL	Indicator Lamp Option POD	Product Types										
	<p>Ideal complimentary module where multiple interlocks are used for enhanced identification of status.</p> <ul style="list-style-type: none"> <li>• Easy, clear identification of machine status</li> <li>• Can be modified to suit one or two lamps</li> <li>• Standard colours are red and yellow, other colours are available to suit</li> </ul>	<table border="1"> <thead> <tr> <th>Description</th> <th>Ref N°</th> </tr> </thead> <tbody> <tr> <td>Stand alone</td> <td>PODL</td> </tr> <tr> <td>For mounting to LOK module</td> <td>LOKPODL</td> </tr> <tr> <td>Mounted to LOK module</td> <td>L</td> </tr> <tr> <td>AS-Interface</td> <td>PODLASI</td> </tr> </tbody> </table>	Description	Ref N°	Stand alone	PODL	For mounting to LOK module	LOKPODL	Mounted to LOK module	L	AS-Interface	PODLASI
		Description	Ref N°									
Stand alone	PODL											
For mounting to LOK module	LOKPODL											
Mounted to LOK module	L											
AS-Interface	PODLASI											

PODB	Pushbutton option POD	Product Types										
	<p>Ideal for use as an emergency stop or request to start/stop.</p> <ul style="list-style-type: none"> <li>• Request start/stop at the gate</li> <li>• Can be modified to suit one or two pushbuttons</li> <li>• Easy, reliable interface with machine controls</li> </ul>	<table border="1"> <thead> <tr> <th>Description</th> <th>Ref N°</th> </tr> </thead> <tbody> <tr> <td>Stand alone</td> <td>PODB</td> </tr> <tr> <td>For mounting to LOK module</td> <td>LOKPODB</td> </tr> <tr> <td>Mounted to LOK module</td> <td>B</td> </tr> <tr> <td>AS-Interface</td> <td>PODBASI</td> </tr> </tbody> </table>	Description	Ref N°	Stand alone	PODB	For mounting to LOK module	LOKPODB	Mounted to LOK module	B	AS-Interface	PODBASI
		Description	Ref N°									
Stand alone	PODB											
For mounting to LOK module	LOKPODB											
Mounted to LOK module	B											
AS-Interface	PODBASI											

**amGard Application Example V**

ATLOK024024K CLIN

Removal of the key from the pod selects machine stop at the end of a run down cycle. When the solenoid within the connected gate switch has been energised access can be gained. The operator can take the safety key into the hazardous area preventing restart and/or enable teach mode function by using a stand alone Pod (PODK).

This key can also create a link to the Fortress mGard range. By inserting this key into mGard mechanical door locks used to lock doors inside the guarded area.



AMLOK024024 & ATLOK024024

The solenoid controlled safety switch body (LOK) can be equipped with two different head types, creating door/hatch lock configurations that restrict access to the safeguarded area until it is safe to enter.

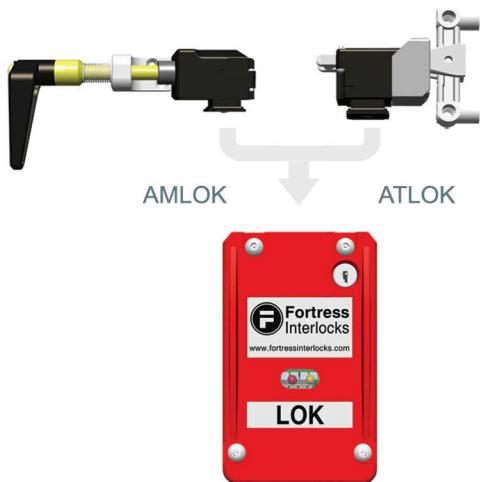

AMSTOP024 & ATSTOP024

The safety switch body (STOP) can be equipped with two different head types. These configurations select machine stop and detect the position of doors/hatches that gives access to the safeguarded area or machine.

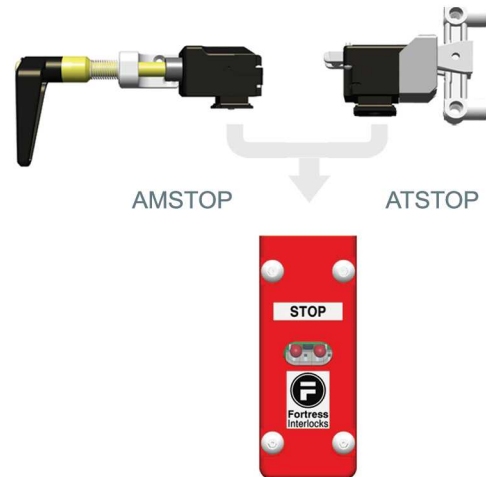

AmGard Technical Specifications

Materials	Zinc Alloy to BSEN12844, Stainless Steel to BS3146
Paint Finish	Gloss Polyester Powder Coat on Passivated Base Material
Colour	Red, Black and Stainless Steel
Ingress Protection	IP67 (DIN 400050)
Operating Force	0.5N
Retention Force Locked	2500N (for all door lock configurations)
Maximum Approach Speed	20m/minutes (for door lock configurations)
Mechanical Life	>1,000,000 Switching Cycles
Maximum Frequency of Ops	7,200/hour
Ambient Temperature	-5°C to + 40°C (mean over 24 hrs = +35°C)
Maximum Wire Cross-Section to fit connector	2.50mm <sup>2</sup>
Connector Type	Spring Activated Vibration Proof Block
Switch Conformance	DIN VDE 0660 Part 206 & IEC

Switching Specifications

Switching Principal	Positive Break (standard)
Switch Control	3A
Switching Voltage	230V AC Max
Switching Contact Element	4NC/2NO (LOK), 2NC/1NO (STOP) and 2NO/2NC (PODK)
Isolating Distance	2 x 2mm per Switch Element
Contact Material	90% Silver and 10% Nickel
Utilisation Category	AC 15 or DC 13
Control Voltage	24V AC/DC, 48V AC/DC, 110V AC or 230V AC
Insulating Resistance	20M Ohm
Insulating Voltage	2500V AC
Solenoid Power Rating	12W (current at Nominal 24V DC = 500mA. Quasient current = 350mA)
Solenoid Rating (Duty Cycle)	100%
Solenoid Voltage	24V AC/DC, 48V AC/DC, 110V AC and 230V AC
Solenoid Voltage Tolerance	90% to 110% of nominal

**Lock and Key Specifications**

Fortress locks have over 200,000 different lock combinations. Besides the standard basic (CL) it also is also possible to have a master series (ML) which can be operated by a special cut master key (MLK-SUGS) that fits on any mastered lock in a specific mastered lock series. For ease of use all Fortress locks provide key insertion in two directions.

**Lock and key engravings**

Each different key combination is allocated with an engraved code onto the lock and key, of up to maximum 30 characters (3 lines of 10 characters), this engraving code is used to identify locks and keys and is recorded in a database for continuous cross reference. Required engravings are therefore to be provided with each order.

Standard		<b>CLIN lock</b> Standard CL lock no dustcover		<b>CLIS lock</b> Standard CL lock with stainless steel dustcover		<b>CLSS lock</b> Full Stainless Steel CL lock with stainless steel dustcover		<b>CLK-SUS</b> Standard key for use on all CL lock types
		<b>MLIN lock</b> Masterable ML lock no dustcover		<b>MLIS lock</b> Masterable ML lock with stainless steel dustcover		<b>MLSS lock</b> Full Stainless Steel masterable ML lock with stainless steel dustcover		<b>MLK-SUGS</b> Standard cut key for use on all ML type locks
								<b>MLK-SUCM</b> Master cut key for use on all ML lock types

As an option Fortress locks can also be supplied with Padlockable dustcovers, that incorporates two padlock holes which can be fitted with lockout hasps and scissor hasps between 3mm and 8mm in diameter as shown below.

Dustcover Options		<b>CLDC</b> Stainless Steel Dustcover		<b>LOH3</b> Lock-Out Hasp		<b>LOS3</b> Lock-Out Scissor Hasp	<p>Key and lock engravings</p> <p>Maximum 30 characters (3 lines of 10 characters)</p>
		<b>PLDC</b> Stainless Steel Padlockable Dustcover		<b>LOH3C</b> Lock-Out Hasp c/w Cable		<b>LOS3C</b> Lock-Out Scissor Hasp c/w Cable	

**Sample Configurations**



**ATA1STOP024 CLIS**

A tongue operated access lock with control switch to safeguard a hatch. Access is only possible after isolation of the machine power, where the access keys are released after the machine is switched off.











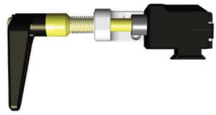

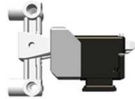



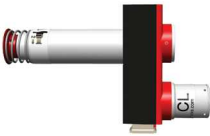

**SBILOK024024IR**

A solenoid controlled safety switch with internal release function and a slidebar operated actuator for effective access.

The high ingress protection class (IP67) makes amGard most suitable for any outdoor use (when mounted correctly).

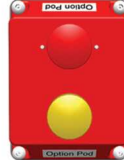

<b>Head Modules</b> <b>Adaptors</b> <b>Electrical Switching / Locking</b> <b>Option PODs</b>	<p>Cap</p>  <p>CP</p>	<p>Handle Actuator &amp; Head</p>  <p>AM</p>	<p>AM Lock-Out Clip</p>  <p>AML</p>	<p>Tongue Actuator &amp; Head</p>  <p>AT</p>	<p>AT Lock-Out Clip</p>  <p>ATL</p>	<p>Sidebar</p>  <p>SBN No Spring &amp; no Internal Release SBS Spring Loaded SBI Internal Release</p>
	<p>Safety Key Adaptor</p>  <p>S1 S1 » S5</p>	<p>Access Key Adaptor</p>  <p>A1 A1 » A5</p>	<p>Single Lock-Out Padlock Adaptor</p>  <p>LO</p>	<p>Dual Lock-Out Padlock Adaptor</p>  <p>LT</p>	<p>Internal Release Adaptor</p>  <p>IRA</p>	<p>Foot</p>  <p>FOOT</p>
	<p>Safety Switch Body</p>  <p>STOP</p> <p>AS available</p>	<p>Solenoid Controlled Switch Body</p>  <p>LOK Power to Unlock LOKPL Power to Lock</p> <p>AS available</p>	<p>AS available</p>  <p>LOKIR Internal Release &amp; Power to Unlock LOKPLIR Internal Release &amp; Power to Lock</p>	<p>Explosion Protected Safety Switch Body</p>  <p>STOPXP UL/CSA certified STOPTX ATEX certified</p> <p>CE II 2G c</p>		
	<p>Key Switch Pod</p>  <p>PODK</p> <p>AS available</p>	<p>Pushbuttons Pod</p>  <p>PODB</p> <p>AS available</p>	<p>Indicator Lamps Pod</p>  <p>PODL</p> <p>AS available</p>			

**eGard** is the new totally modular approach to controlling access to hazardous machinery and equipment. A compact access and control system has been developed that enables a selection of configurations including mechanical trapped key interlocks, electrical safety gate switch interlocks and electrical operator controls, either as separate devices or intergrated into one device.

The system features patented mechanical and electrical connections between every module. It simply clips together and the internal network is self-configuring. With over 4,000 billion possible combinations of modules it can be easily customised for every access and control application. The eGard product range is defined into three sections: head modules, core modules and base modules.

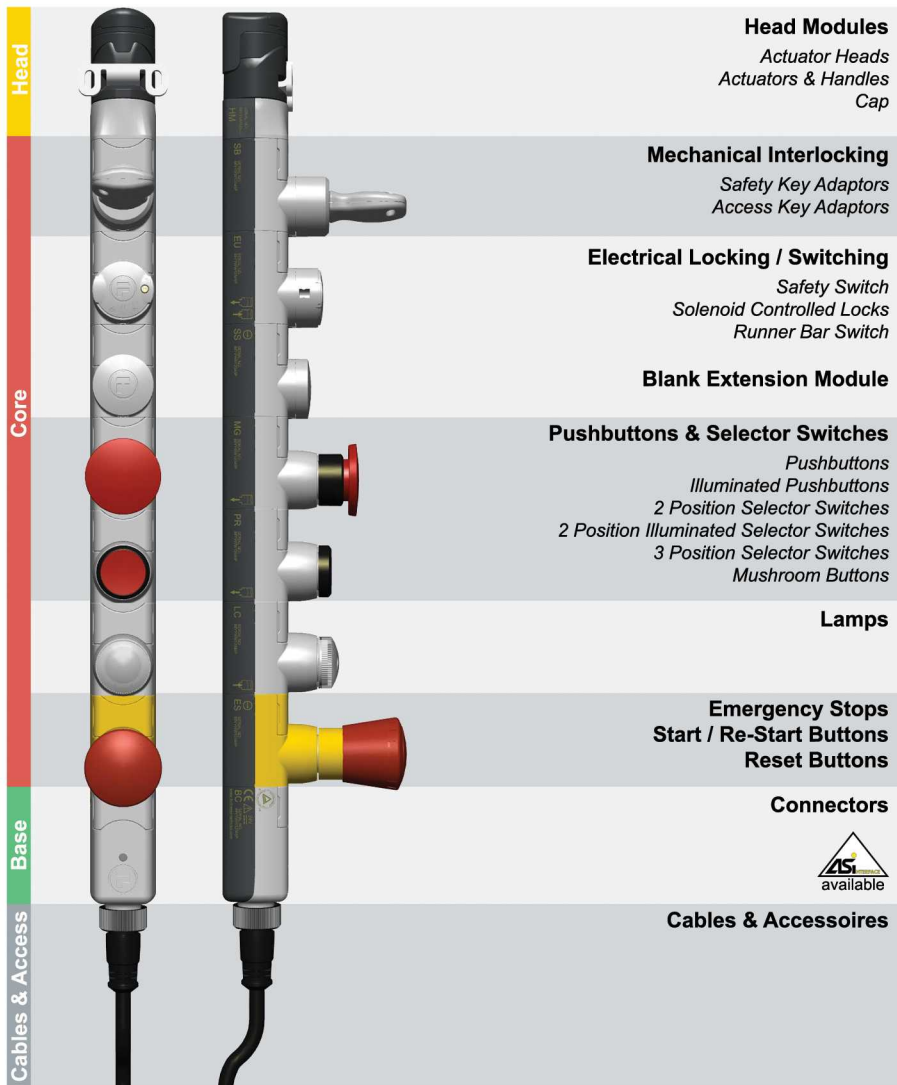

**Module Configuration & Assembly:**

A module stack consists of a head module (actuator head or cap), at least one core module (switches, buttons or LED's) and a base module for data-transfer to the PLC-control. Base modules are also available for AS-interface BUS systems. Maximum number of modules = 11 (including head and base).

**Mounting Principle:**

This mechanical and electrical combinable eGard closure-system configured, for PLC-systems, consists of connectable modules with different functions and can be used on hinged and sliding doors or just as a control configuration. The stacks can be mounted directly onto a flat surface, doors or extruded profiles, without the need for mounting plates or brackets.

**Configuration and Wiring Setup:**

The wiring is configuration specific. The eGard range incorporates safety circuits and standard I/O (input / output) in a single product. The safety and control circuits are separate through all of the modules and are terminated in the head module. The control circuits form an internal network.

**Base connector selection:**

There are selections of different base modules, that enable the connection of just the safety circuits (4-pole) or both, the safety and control circuits (14-pole up to 8 I/O). Alternatively a 4-pole ASI-connector can be used for bus-systems (max. 4 I and 4 O). eGard configurations are suitable for use in category 4 applications, acc. to standard EN 954-1 and EN 13849.

**Connection:**

Depending on amount of modules 4- or 14-pole, coupling with the 2 m, 5 m, 10 m or 20 m ready made cable.

**Material and Surface Versions:**

Module housings made of plastic PBT and 304 stainless steel internals. Upper part light grey coloured, lower part dark grey coloured.

**Protection Class:**

The protection class conforms to IP 65 when correctly mounted.

- Locking, switching and machine controls in one configuration with one PreFab connector
- From conventional to AS-i bus by just changing the connector
- Simply add modules to existing configurations
- All eGard mechanically tested to 1 million operations
- Type tested and approved by TÜV Rheinland Group, UL and CSA Listed



## eGard Application Examples

eGard offers the possibility to configure solutions to safeguard, regulate access and control of machinery and/or guarded areas, as is shown in the automated production line below.

- 1 HMSBEUSSP4LCBC-AH**  
Handle operated door lock with a safety key, a solenoid controlled safety switch, an access request button and an indication lamp (for full body access doors).
- 2 HCABSSBS**  
The safety key from configuration 1 can be inserted in the key switch module to activate a teach mode function.
- 3 HMSSBS-AH**  
Handle operated door lock with safety switch, that terminates the machine after opening the door (for part body access doors).
- 4 HCEMBB**  
A monitored emergency stop.

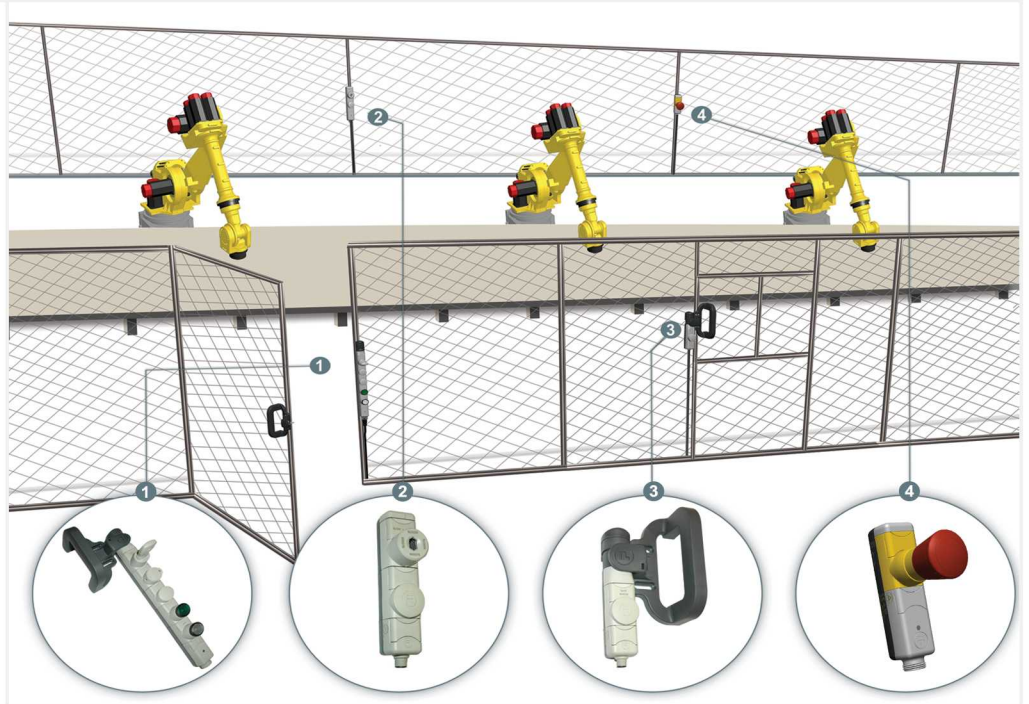

## Trapped Key Interlocking Principles

A simple mechanical system of interlocking, without need for wiring to the access gates, keys are trapped and freed in a defined logic sequence, for machine controls, as well as allowing access when the guarded area or machine is safe to enter.

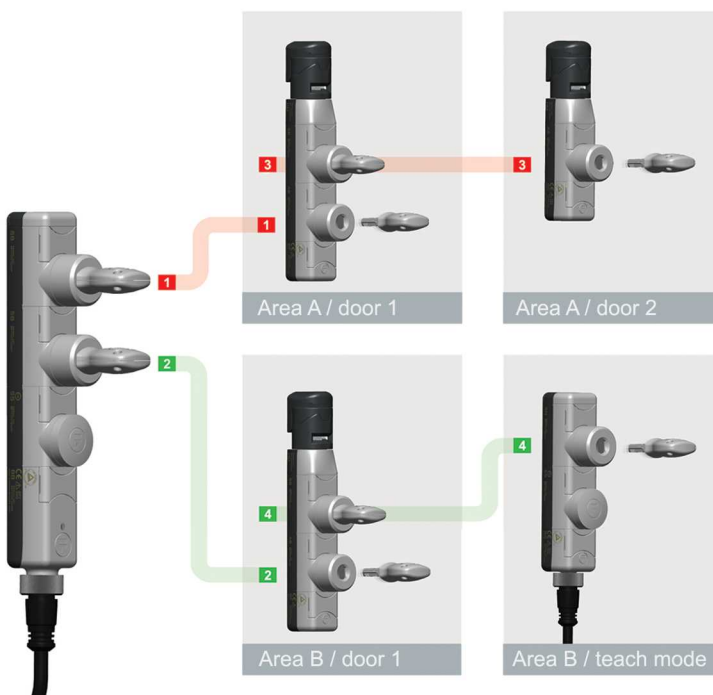

By turning key 1 or 2 in the key controlled switch configuration, the dual safety circuits are broken and the machine stopped.

**Key 1** can be used to open door 1 of the safeguarded area A.

**Key 2** can be used to open door 1 of the safeguarded area B.

**Key 3** is a safety key that keeps key 1 trapped in the door lock preventing machine restart and can also be used to open a door inside area A.

**Key 4** is a safety key that prevents machine restart and can also be used to start machine teachmode inside area B. using a key controlled switch configuration.

### Trapped Key Interlock Interfacing

Interfacing trapped key interlocks with safety gate switch and/or control functions does offer unique and new methods to improve, optimise, and rationalise the implementation of all these safety related functions into one system.



## General Guidelines

- A configuration must be made up of one head module, at least one core module and one base module
- Configuration sequence is: head module, safety locks, access locks, solenoid, safety switches, control modules and base.
- Maximum number of modules = 11 (including head & base)

## Head Modules

- HF incl. fixed actuator
- HM head only



### Actuator Head

For gate switch and door lock configurations.

- Rotatable through 360 degrees
- Top and side entry
- Operating force 5 to 10N
- Retention force 1000N

- HC



### Cap

Used to terminate all non door lock or gate switch configurations.

- Used in mechanical exchange box, machine control or key switch configurations.

## Actuators

- AF fixed actuator
- AG actuator used in handles



### Fixed Actuator

- Fixed actuator suitable for mounting for either sliding or hinged doors.

*Must be used in combination with a HM head module.*

- AH Hinged door actuator
- AS Sliding door actuator



### Handle Actuators

- Handle actuators suitable for bracketless mounting for either sliding or hinged doors.

*Must be used in combination with a HM head module.*

Handles for hinged and sliding doors:

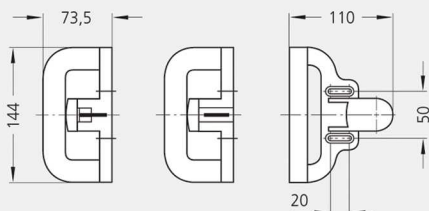

AH



AS

**Mechanical Interlocking**

Mechanical lock modules - for use in trapped key configurations (e.g. key switches, exchange boxes and door locks). It can also be used in conjunction with safety gate switches to add further levels of access control (e.g. modular safety keys to prevent accidental lock in of personnel in full body access applications or additional key transfer).

**Access Key Module**

- AB standard lock
- QB master lock



For access (request) functions.

- Robust radial disc tumbler lock
- >3000 combinations
- 10 mastered combinations (can be used with all 3000 individual combinations)
- No key included
- Max No of mechanical locks = 6

**Safety Key Module**

- SB standard lock
- GB master lock



To prevent accidental lock in of personnel.

- Robust radial disc tumbler lock
- >3000 combinations
- 10 mastered combinations (can be used with all 3000 individual combinations)
- Key included
- Max No of mechanical locks = 6

**Keys**

- KS standard key
- KM master key



Master key can only be used in combination with masterable lock modules.

**Electrical Locking / Switching**

eGard offers four different electrical locking/switching modules. The safety switch module, is driven by either the operation of the head module (removal of actuator or handle) or a mechanical lock. The module is for instance used to switch "off" an installation when opening the door. The solenoid controlled lock is also able to lock a door or trap a key until the area is safe to enter. The runner bar switch only detects the operation of the head module or mechanical lock and translates this into a I/O signal.

**Safety Switch**

SS



Can be driven by either the operation of the head module (removal of actuator) or a mechanical lock.

- Operates on dual safety circuits
- 2 force break positive make NC safety contacts (uses none of the I/O pins)



**Solenoid Controlled Lock**

- EU power to unlock
- EL power to lock



To electrically lock a door or trap a mechanical key. This module restricts access until it is safe.

- Both have 1NO contact to monitor when the module is locked
- Uses 1 output and 1 input pin
- A high output indicates that the solenoid has successfully locked the runnerbar



RB



### Runner Bar Switch

Additional monitoring contact. Can be driven by either the runner bar operation of the head module (removal of actuator) or a mechanical lock.

- 1NO monitoring contact (each runner bar status module uses 1 output pin)



## Extension Blank Modules

EB



### Blank Extension Module

Additional blank module for extending a configuration.

*Generally used for spacing between core modules.*

## Pushbutton Modules

- PG** green **PY** yellow
- PR** red
- PW** white
- PB** black
- PZ** blue



### Pushbuttons - Flat

- Uses 1 output pin
- All pushbuttons have 1NO contact

*Other colours are available on request.*



- P1** red **P7** white
- P2** yellow
- P3** green
- P4** clear
- P6** blue



### Pushbuttons - Flat Illuminated

- Uses 1 output pin and 1 input pin
- All pushbuttons have 1NO contact

*Other colours are available on request.*



- M1** **MB** black
  - M2** **MR** red
  - M3** **MY** yellow
  - MG** green
- non-latching  
latching

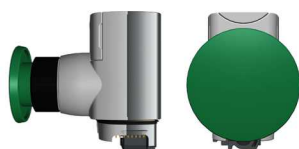

### Pushbuttons - 40mm Mushroom

- Uses 1 output pin
- All mushroom buttons have 1NO contact
- non-latching - spring return to original position
- latching - stay in each switch position

*Other colours are available on request.  
Red mushroom buttons cannot be used in the USA.*



eGard simply clips together and provides a vast number of options. Modules such as stop and start switches and indicator lights can be included in the one unit, with or without gate switch modules. This eliminates much of the wiring and connection time involved with control panels. Ease of installation also provides a huge cost saving for specifiers.





**Selector Switches**

- 2A 2D** black
  - 2B 2E** red
  - 2C 2F** green
  - 2G 2H** white
- non-latching  
latching



**2 Position Selector Switches**

- All 2 position selector switches have 1NO contact
- Each 2 position selector switch uses 1 output pin
- Non-latching - spring return to original position
- Latching - stay in each switch position



Other colours are available on request.

- 3A 3D** black
  - 3B 3E** red
  - 3C 3F** green
  - 3G 3H** white
- non-latching  
latching



**3 Position Selector Switches**

- All 3 position selector switches have 2NO contacts
- Each 3 position selector switch uses 2 output pins
- Non-latching - spring return to original position
- Latching - stay in each switch position



Other colours are available on request.

- 2J 2N** red
  - 2K 2O** green
  - 2L 2P** white
- non-latching  
latching



**2 Position Illuminated Selector Switches**

- All 2 position illuminated selector switches have 1NO contacts
- Each 2 position illuminated selector switch uses 1 input pin and 1 output pin
- Non-latching - spring return to original position
- Latching - stay in each switch position



Other colours are available on request.

- K1** 2 position
- K2** 3 position



**Ronis Key Switch**

- 2 position switch uses 1 output pin and 1NO contact
- 3 position switch uses 2 output pins and 2NO contacts
- Including Ronis key
- Latching - stay in each switch position

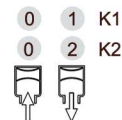

K1 : Siemens 3SB30 00-4AD01  
K2 : Siemens 3SB30 00-4DD01

- K3** 2 position
- K4** 3 position



**BKS ET Key Switch**

- 2 position switch uses 1 output pin and 1NO contact
- 3 position switch uses 2 output pins and 2NO contacts
- Excluding BKS ET key
- Latching - stay in each switch position

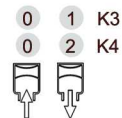

K3 : Siemens 3SB30 00-5AE31 (E2 : Volkswagen)  
K4 : Siemens 3SB30 00-5AE51 (E7 : Volkswagen)

**Lamps**

- LB** blue
- LY** yellow
- LC** clear
- LG** green
- LR** red
- LW** white



**LED Lamps**

- LED status indicator
- Each lamp uses 1 input pin



Other colours are available on request.

Emergency Stops / Start Re-Start

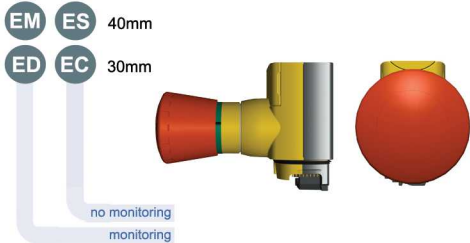

Twist Release Emergency Stop

- 2 force break positive make NC Safety contacts (uses none of the I/O pins)
- Monitored version (EM) also has 1NO monitoring contact, uses 1 output pin
- 30mm or 40mm button

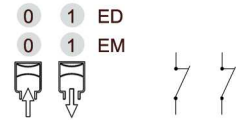

Standard twist release operates on dual safety contacts.

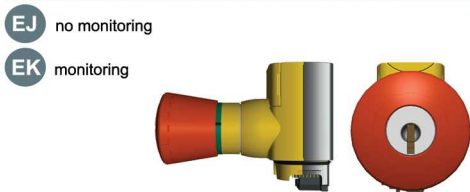

Emergency Stop with Key Operated Reset

- 2 force break positive make NC Safety contacts (uses none of the I/O pins)
- Monitored version (EK) also has 1NO monitoring contact, uses 1 output pin
- With Ronis key operated reset function
- 40mm button



Standard twist release operates on dual safety contacts.



Start Re-start Key Switch

- Start restart key switch, operating on safety circuits
- Uses 1 NO and 1 NC
- For safety relay re-set
- With Ronis key operated reset function
- Latching - stay in each switch position



Start Re-start

- Start restart pushbutton, operating on safety circuits
- Uses 1 NO and 1 NC
- For safety relay re-set



Connectors



Foot

For terminating mechanical configurations (no wiring).



Safety Only Connector

4 pin M12 for connecting dual safety circuits.

## Safety & Control Connectors

- BB** 2 I/O sourcing output
- BC** 8 I/O sourcing output
- BD** 2 I/O sinking output
- BE** 8 I/O sinking output



- All versions connect dual safety circuits and either up to 2 inputs/outputs or up to 8 inputs/outputs
- 14 pin for connecting to 24V DC

## AS-Interface Connectors

- BA** AS-i safety & control
- BH** AS-i safety only
- BG** AS-i control only



- BA** AS-i connectors 4 pin M12 for connecting dual safety circuits and up to 4 inputs and up to 4 outputs (uses two addresses)
- BH** AS-i connectors 4 pin M12 for connecting dual safety circuits only (uses one address)
- BG** AS-i connectors 4 pin M12 for connecting controls only up to 4 inputs and up to 4 outputs (uses one address)

## Cables & Accessories

### 4 Pin Cables

- 24** 2m
- 54** 5m
- 14** 10m
- 04** 20m



- Single ended straight connector
- 4 pin M12

### 14 Pin Cables

- 21** 2m
- 51** 5m
- 10** 10m
- 20** 20m



- Single ended straight connector
- 14 pin

## Marked Legend Plates

- VG** landscape grey
- VY** landscape yellow
- HG** portrait grey
- HY** portrait yellow
- DG** image grey
- DG** image yellow



- Grey (or yellow for emergency stop modules)
- For vertically mounted configuration (landscape legend plate) up to 3 lines of 17 digits long and 3mm high
- For horizontally mounted configuration (portrait legend plate) up to 2 lines of 11 digits long and 3mm high
- Both portrait and landscape legend plates are also available with an image (DWG format)



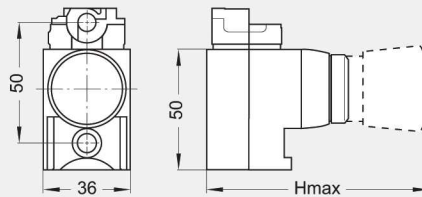
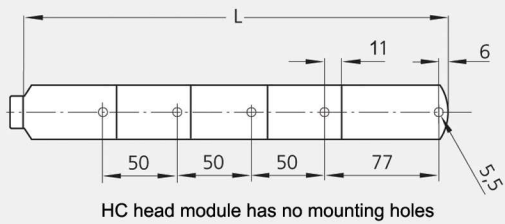

Designation	Hmax (mm)
Key Modules	100
Solenoid Locks	55
Safety Switch	48
Runner Bar	48
Emergency Stops	100
Ronis/BKS Key modules	96
Pushbuttons	59
Mushroom Buttons	76
Selector Switches	76
Lamps	63
Connectors/Heads	35

**Assembly & Mounting of Modules \***

1. The upper module will be connected to the lower module by simply clicking together.
2. Inserting the joining tube through the middle bore secures and seals the module connection.
3. After connecting all modules according to step 2 the configuration can be mounted e.g. on a grooved profile by slot nuts and cylindrical head screws M 5, DIN 912.  
(or alternatively bolting on flat surface)
4. Finally the cover caps will be pushed on the connecting bores of the module housings.

- \* To assure IP 65, all modules must be fixed.
- \* Complete ordered configurations are supplied fully assembled.

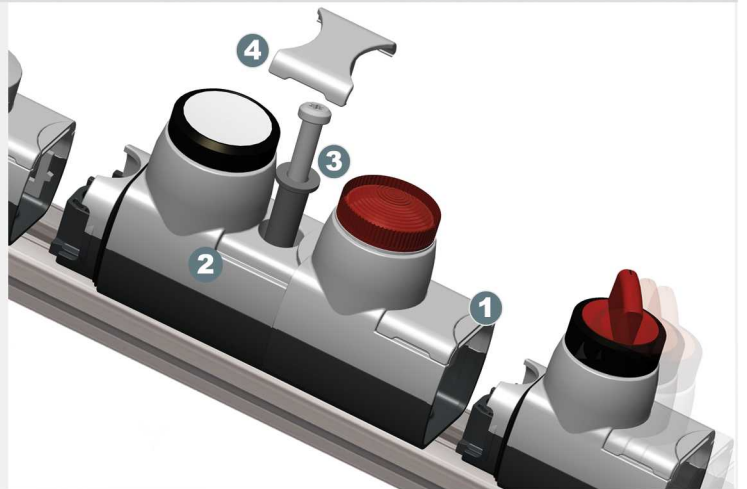

**Configuration Rules**

1. A configuration must be made up of one head module, at least one core module and one base module.
2. Maximum No of modules = 11 (including head & base).
3. Configuration sequence is: head module, safety locks, access locks, solenoid, safety switches, control modules and base.
4. The start / restart (SR, ST, SW, SX, SY & SZ) module cannot be used in stacks with another module that works on the safety circuits.
5. All eGard configurations are suitable for use in Installation Category 4 (to EN954-1) applications apart from ones combining an e-stop and a gate switch having an ES and SS in same stack (this is Installation Category 3 EN954-1)

**Electrical Guidelines**

Control modules with inputs/outputs (I/O) can be configured in any order in the stack (the internal eGard network is self configuring). Table 1 shows how many I/O connections can be made using the different types of connector, and table 2 shows each core modules I/O requirements.

Ref N°	Description	Max I/O	Connects safety circuits
BS	Safety Only	Zero	Yes
BB	Safety and Control sourcing	Max 2 I/O	Yes
BC	Safety and Control sourcing	Max 8 I/O	Yes
BD	Safety and Control sinking	Max 2 I/O	Yes
BE	Safety and Control sinking	Max 8 I/O	Yes
BA	Safety and Control AS-i	Max 4I & 4O	Yes
BH	Safety Only As-i	Zero	Yes
BG	Control Only As-i	Max 4I & 4O	No

table 1: max I/O connections per base connector type

I/O relative to eGard		inputs (I)	outputs (O)	connects to safety circuits
Head Modules	HF, HM, HC	0	0	-
Mechanical Interlocking	AB, SB	0	0	-
Safety Switches	SS	0	0	yes
Solenoid Controlled Locks	EU, EL	1	1	-
Runner Bar Modules	RB	0	1	-
Blank Extension Modules	EB	0	0	-
Pushbuttons Flat	PB, PG, PR, PW, PZ, PY	0	1	-
Pushbuttons Flat Illuminated	P1 - P7	1	1	-
2 Position Selector Switches	2A - 2H	0	1	-
3 Position Selector Switches	3A - 3H	0	2	-
2 Position Illuminated Selector Switch	2J, 2K, 2L, 2N, 2O, 2P	1	1	-
2 Position Key Switch	K1, K3	0	1	-
3 Position Key Switch	K2, K4	0	2	-
Pushbutton 40mm Mushroom	M1, M2, MB, MR, MG	0	1	-
Lamps	LR, LG, LC, LB, LW, LY	1	0	-
Emergency Stop	ES, EC	0	0	yes
Monitored Emergency Stop	EM, ED	0	1	yes
Key Operated E-stop	EJ	0	0	yes
Monitored Key Operated E-stop	EK	0	1	yes
Start / Re-start Buttons	SR, ST, SW, SX, SY, SZ	0	0	yes
Key Operated Start / Re-start Buttons	SC	0	0	yes

table 2: Core module I/O requirements

Designation

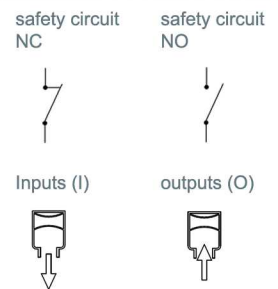

Technical Information

Base Modules	Max. current	Max. Relative Humidity	93(+/-3)% without any dew on the device
4 pole	200 mA	Ingress Protection	IP65
14 pole	200 mA		
4 pole AS-i	75 mA		
Temperature Range	-5... + 40 C°		
Operating Voltage	24V DC		

Creating an Article Code

An eGard configuration article code can simply be created by adding up the single used module part numbers in sequence from head to base. The legend plates, cables, and door actuators must be ordered separately and are not part of the configuration article code. Below an example of how to create an eGard part number:

The complete part number of the example configuration is: HFSBELSSPGWPBC - 51

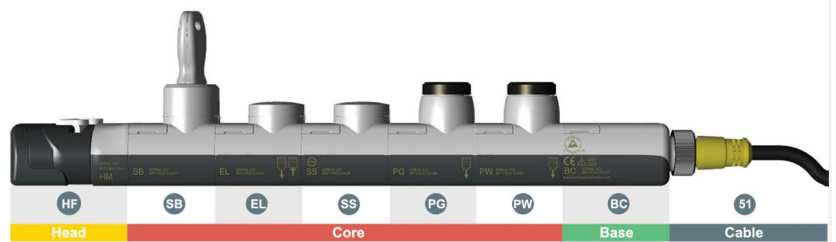

Wiring Schemes

By using the eGard configurator ([www.fortressinterlocks.com](http://www.fortressinterlocks.com)) you are able to simply extract a wiring diagram of each configuration. You can also contact our Technical Sales department for any assistance. Shown below is a wiring diagram for both the 14 pin (safety & control) as the 4 pin (safety only and AS-i) connector.

I/O Assigned from base upwards	Wire Colours	Connector Pins
+24 V	Brown	4
0 V	Blue	6
Safety circuit 1	White	10
Safety circuit 1	Grey	13
Safety circuit 2	Brown/Yellow	5
Safety circuit 2	Brown/Green	12
I/O 0	Red/Blue	11
I/O 1	White/Yellow	3
I/O 2	White/Green	2
I/O 3	Grey/Pink	1
I/O 4	Pink	9
I/O 5	Green	8
I/O 6	Yellow	7
I/O 7	Red	14

table 3: BC 14 Pin Control & Safety Connector wiring scheme

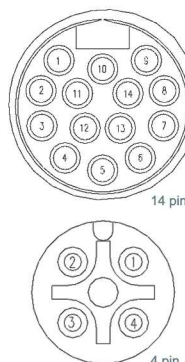

I/O Assigned from base upwards	Wire Colours	Connector Pins
Safety circuit 1	Brown	1
Safety circuit 2	White	2
Safety circuit 1	Blue	3
Safety circuit 2	Black	4

table 4: BS 4 Pin Control only Connectors wiring scheme

Pins	Description
1	AS-i +
2	-
3	AS-i -
4	-

table 5: 4 Pin AS-i connector wiring scheme

Head	<b>Head/Cap</b> <ul style="list-style-type: none"> <li>HF Head incl. Fixed Actuator</li> <li>HM Head Only</li> <li>HC Cap</li> </ul>		<b>Handles &amp; Actuators</b> <ul style="list-style-type: none"> <li>AF Fixed Actuator</li> <li>AG Actuator used in Handles</li> <li>AH Hinged Door Handle</li> <li>AS Sliding Door Handle</li> </ul>	
	<b>Mechanical Interlocking</b> <ul style="list-style-type: none"> <li>AB Standard Lock</li> <li>QB Master Lock</li> <li>SB Standard Lock</li> <li>GB Master Lock</li> <li>KS Standard Key</li> <li>KM Master Key</li> </ul>		<b>Electrical Locking/Switching</b> <ul style="list-style-type: none"> <li>Solenoid Controlled Lock</li> <li>EU Power to Unlock</li> <li>EL Power to Lock</li> <li>SS Safety Switch</li> <li>RB Runner Bar Switch</li> </ul>	
Core	<b>Pushbuttons</b> <ul style="list-style-type: none"> <li>Flat: PG green, PY yellow, PR red, PB black, PW white, PZ blue</li> <li>Flat Illuminated: P1 red, P4 clear, P2 yellow, P6 blue, P3 green, P7 white</li> <li>40mm Mushroom Latching: M1 black, M2 red, M3 yellow</li> <li>40mm Mushroom Non-Latching: MB black, MR red, MY yellow, MG green</li> </ul>		<b>Lamps</b> <ul style="list-style-type: none"> <li>LB blue, LR red, LC clear, LW white, LG green, LY yellow</li> </ul>	
	<b>Selector Switches</b> <ul style="list-style-type: none"> <li>2 Position Latching: 2A black, 2B red, 2C green, 2G white</li> <li>2 Position Non-Latching: 2D black, 2E red, 2F green, 2H white</li> <li>3 Position Latching: 3A black, 3B red, 3C green, 3G white</li> <li>3 Position Non-Latching: 3D black, 3E red, 3F green, 3H white</li> <li>2 Position Illuminated Latching: 2J red, 2K green, 2L white</li> <li>2 Position Illuminated Non-latching: 2N red, 2O green, 2P white</li> </ul>		<b>Start / Re-Start</b> <ul style="list-style-type: none"> <li>SC Start / Re-Start Key Switch</li> <li>SR blue, ST black, SY white, SX red, SZ yellow</li> </ul>	
Base	<b>Selector Switches</b> <ul style="list-style-type: none"> <li>Ronis Key Switch Latching: K1 2 Position, K2 3 Position</li> <li>BKS ET Key Switch Latching (E2 and E7 Volkswagen): K3 2 Position (E2), K4 3 Position (E7)</li> </ul>		<b>Emergency Stops</b> <ul style="list-style-type: none"> <li>Twist-Release 40mm Emergency Stop: EM Monitoring, ES No Monitoring</li> <li>Twist-Release 30mm Emergency Stop: ED Monitoring, EC No Monitoring</li> <li>E-stop with Ronis Key Operated Reset: EJ Monitoring, EK No Monitoring</li> </ul>	
	<b>Connectors</b> <ul style="list-style-type: none"> <li>BF Foot</li> <li>BS Safety Only Connector (4 pin)</li> <li>BB 2 I/O Sourcing Output (14 pin)</li> <li>BC 8 I/O Sourcing Output (14 pin)</li> <li>BD 2 I/O Sinking Output (14 pin)</li> <li>BE 8 I/O Sinking Output (14 pin)</li> <li>AS-i Connector (4 pin): BA AS-i Control &amp; Safety (4I &amp; 4O), BH AS-i Safety Only, BG AS-i Control Only (4I &amp; 4O)</li> </ul>			
Cables & Access	<b>Cables</b> <ul style="list-style-type: none"> <li>4 pin M12: 24 2m, 14 10m, 54 5m, 04 20m</li> <li>14 pin: 21 2m, 10 10m, 51 5m, 20 20m</li> </ul>		<b>Marked Legend Plates</b> <ul style="list-style-type: none"> <li>START: VG Landscape Grey, VY Landscape Yellow</li> <li>ACCESS: HG Potrait Grey, HY Potrait Yellow</li> <li>Image: DG Image Grey, DY Image Yellow</li> </ul>	
	<b>Ref N°</b>		<b>Ref N°</b>	



A HALMA COMPANY

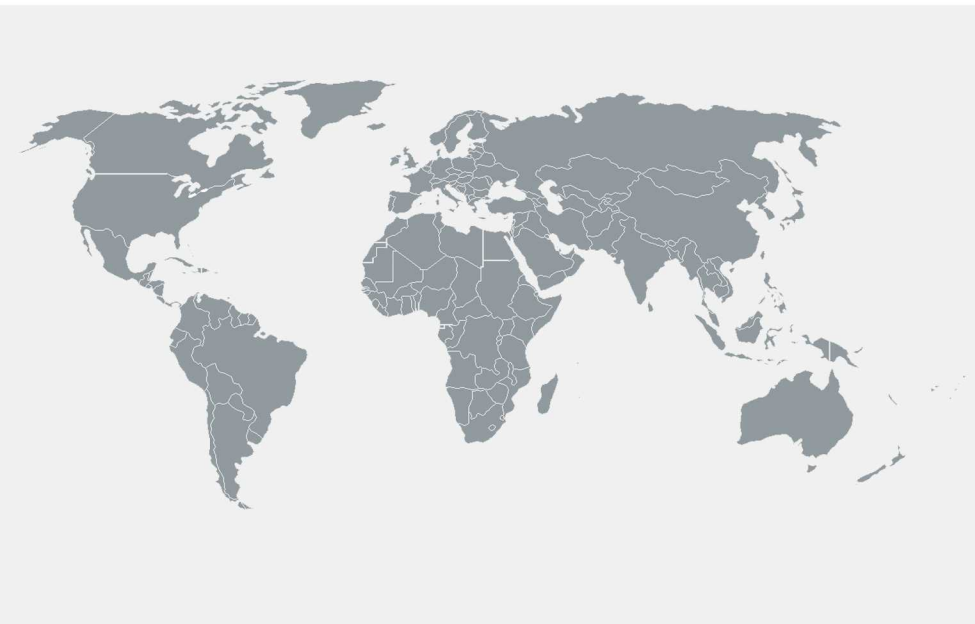

**Fortress Interlocks Ltd**

- ☎ +44 (0)1902 349000
- ☎ +44 (0)1902 349090
- ✉ sales@fortressinterlocks.com

**Fortress Interlocks Europe**

- ☎ +31 (0)70 4159345
- ☎ +31 (0)70 3192128
- ✉ europe@fortressinterlocks.com

**Fortress Interlocks USA**

- ☎ +1 (859) 578 2390
- ☎ +1 (859) 341 2302
- ✉ us@fortressinterlocks.com

**Fortress Systems Pty Ltd**

- ☎ +61 (0)3 9587 4099
- ☎ +61 (0)3 9587 4130
- ✉ australia@fortressinterlocks.com

Official Distributor